

AGENDA

HISTORIC PRESERVATION ADVISORY BOARD MEETING
CITY HALL, 385 SOUTH GOLIAD, ROCKWALL, TEXAS
NOVEMBER 16, 2023 IN THE CITY COUNCIL CHAMBERS AT 6:00 PM

(I) CALL TO ORDER

(II) OPEN FORUM

This is a time for anyone to address the Historic Preservation Advisory Board (HPAB) on any topic that is not already listed on the agenda for a public hearing. Per the policies of the City of Rockwall, public comments are limited to three (3) minutes out of respect for the time of other citizens. On topics raised during the OPEN FORUM, please know that the Historic Preservation Advisory Board (HPAB) is not permitted to respond to your comments during the meeting per the Texas Open Meetings Act.

(III) CONSENT AGENDA

These agenda items are administrative in nature or include cases that meet all of the technical requirements stipulated by the Unified Development Code (UDC) and Chapter 38, Subdivisions, of the Municipal Code of Ordinances, and do not involve discretionary approvals.

- (1) Approval of Minutes for the October 19, 2023 Historic Preservation Advisory (HPAB) meeting.

(IV) PUBLIC HEARING ITEMS

This is a time for anyone to speak concerning their issues with a public hearing case. If you would like to speak regarding an item listed in this section, please submit a Request to Address the Historic Preservation Advisory Board (HPAB) (i.e. the yellow forms available at the podium or from staff). The Historic Preservation Advisory Board Chairman will call upon you to come forward at the proper time or will ask if anyone in the audience would like to speak. Please limit all comments to three (3) minutes out of respect for the time of other citizens.

(2) **H2023-019 (ANGELICA GUEVARA)**

Hold a public hearing to discuss and consider a request by Michael Cheatham on behalf of Jake Rashell and Nicole Smith for the approval of a Certificate of Appropriateness (COA) for an addition to an existing single-family home being a *Low Contributing Property* on a 0.25-acre parcel of land identified as Block 120E of the B. F. Boydston Addition, City of Rockwall, Rockwall County, Texas, zoned Single-Family 7 (SF-7) District, situated within the Old Town Rockwall (OTR) Historic District, addressed as 603 E. Rusk Street, take any action necessary.

(3) **H2023-020 (ANGELICA GUEVARA)**

Hold a public hearing to discuss and consider a request by Michael Cheatham on behalf of Jake Rashell and Nicole Smith for the approval of a Small Matching Grant for an addition to an existing single-family home being a *Low Contributing Property* on a 0.25-acre parcel of land identified as Block 120E of the B. F. Boydston Addition, City of Rockwall, Rockwall County, Texas, zoned Single-Family 7 (SF-7) District, situated within the Old Town Rockwall (OTR) Historic District, addressed as 603 E. Rusk Street, take any action necessary.

(4) **H2023-021 (ANGELICA GUEVARA)**

Hold a public hearing to discuss and consider a request by Michael Cheatham on behalf of Jake Rashell and Nicole Smith for the approval of a Building Permit Fee Waiver for an addition to an existing single-family home being a *Low Contributing Property* on a 0.25-acre parcel of land identified as Block 120E of the B. F. Boydston Addition, City of Rockwall, Rockwall County, Texas, zoned Single-Family 7 (SF-7) District, situated within the Old Town Rockwall (OTR) Historic District, addressed as 603 E. Rusk Street, take any action necessary.

(V) DISCUSSION ITEMS

These items are for discussion between staff and the Historic Preservation Advisory Board (HPAB) and relate to administrative information and/or cases that will come forward for action or public hearing at a future Historic Preservation Advisory Board meeting. Public comment on these cases can take place when these items are considered for action by the Historic Preservation Advisory Board.

- (3) Update from Historic Preservation Officer (HPO) regarding historic projects. (RYAN MILLER)

(VI) ADJOURNMENT

The City of Historic Preservation Advisory Board (HPAB) reserves the right to adjourn into executive session at any time to discuss any matters listed on the agenda above, as authorized by Texas Local Government Code §55.071 (Consultation with City Attorney) or any other exception allowed under Chapter 551 of the Texas Local Government Code.

This facility is wheelchair accessible and accessible parking spaces are available. Request for accommodations or interpretive services must be made 48 hours prior to this meeting. Please contact the City Secretary's Office at (972) 772-6406 for further information.

I, Melanie Zavala, Planning and Zoning Coordinator for the City of Rockwall, Texas, do hereby certify that this Agenda was posted at City Hall, in a place readily accessible to the general public at all times, on November 10, 2023 at 5:00 PM, and remained so posted for at least 72 continuous hours preceding the scheduled time of said meeting.

MINUTES



HISTORIC PRESERVATION ADVISORY BOARD MEETING
CITY HALL, 385 SOUTH GOLIAD, ROCKWALL, TEXAS
OCTOBER 19, 2023 IN THE CITY COUNCIL CHAMBERS AT 6:00 PM

2
3 I. CALL TO ORDER
4

5 Chairman Tiffany Miller brought the meeting to order at 6:02 PM. Board members present were Haydon Frasier, Steve Gaskin, Allison McNeely, Ben
6 Lewis and Brandon Litton. Board members absent were Sarah Freed. Staff members present were Director of Planning and Zoning Ryan Miller,
7 Planning Technician Angelica Guevara, and Planning Coordinator Melanie Zavala. Absent from the meeting was Senior Planner Henry Lee and
8 Planner Bethany Ross.
9

10 II. OPEN FORUM
11

12 *This is a time for anyone to address the Historic Preservation Advisory Board (HPAB) on any topic that is not already listed on the agenda for a public hearing.*
13 *Per the policies of the City of Rockwall, public comments are limited to three (3) minutes out of respect for the time of other citizens. On topics raised during*
14 *the OPEN FORUM, please know that the Historic Preservation Advisory Board (HPAB) is not permitted to respond to your comments during the meeting per*
15 *the Texas Open Meetings Act.*
16

17 Chairman Tiffany Miller explained how the open forum is conducted and asked if anyone who wished to speak to come forward at this time; there
18 being no one indicating such Chairman Tiffany Miller closed the open forum.
19

20 III. CONSENT AGENDA

21 *These agenda items are administrative in nature or include cases that meet all of the technical requirements stipulated by the Unified Development Code (UDC)*
22 *and Chapter 38, Subdivisions, of the Municipal Code of Ordinances, and do not involve discretionary approvals.*
23

24 1. Approval of Minutes for the September 21, 2023 Historic Preservation Advisory (HPAB) meeting.
25

26 Vice-Chairman Frasier made a motion to approve Consent Agenda. Board member Gaskin seconded the motion which passed by a vote of 6-0.
27

28 IV. PUBLIC HEARING ITEMS
29

30 *This is a time for anyone to speak concerning their issues with a public hearing case. If you would like to speak regarding an item listed in this section, please*
31 *submit a Request to Address the Historic Preservation Advisory Board (HPAB) (i.e. the yellow forms available at the podium or from staff). The Historic*
32 *Preservation Advisory Board Chairman will call upon you to come forward at the proper time or will ask if anyone in the audience would like to speak. Please*
33 *limit all comments to three (3) minutes out of respect for the time of other citizens.*
34

35 2. H2023-013 (BETHANY ROSS)

36 Hold a public hearing to discuss and consider a request by Morgan Edwards for the approval of a Certificate of Appropriateness (COA) for the replacement of
37 windows on a Non-Contributing Property being a 1150-acre tract of land identified as a portion of Block 22 of the F & M Addition, City of Rockwall, Rockwall
38 County, Texas, zoned Single-Family 7 (SF-7) District, situated within the Old Town Rockwall (OTR) Historic District, addressed as 203 N. Clark Street, and
39 take any action necessary.
40

41 Director of Planning and Zoning Ryan Miller provided a brief summary in regards to the request. The applicant is requesting a Certificate of
42 Appropriateness (COA) for the replacement of windows on a non-contributing property. They are requesting to replace the windows for
43 something more energy efficient. What the applicant is proposing is considered to be like and kind since the windows are not original to the home.
44 This is a discretionary decision to the Historic Preservation Advisory Board (HPAB) this being a COA case staff mailed out 23 notices to property
45 owners and occupants within 200-feet of the subject property. Staff has not received notices in return in regards to the applicants request.
46

47 Board member Gaskin said there would not be a difference since windows already look different.
48

49 Board member Lewis said that there would be no adverse in regards to the windows.
50

51 Chairman Miller opened the public hearing and asked anyone who wished to speak to come forward at this time; there being no one indicating
52 such, Chairman Miller closed the public hearing and brought the item back to the Board for discussion or action.
53

54 Board member Lewis asked what year the house was built.
55

56 Board member Frasier made a motion to approve H2023-013 with gridded windows. Chairman Miller seconded the motion which passed by a vote
57 of 5-1 with Board member McNeely dissenting.
58

59
60 3. H2023-014 (BETHANY ROSS)

61 Hold a public hearing to discuss and consider a request by Morgan Edwards for the approval of a Small Matching Grant for the replacement of windows on a
62 Non-Contributing Property being a 1150-acre tract of land identified as a portion of Block 22 of the F & M Addition, City of Rockwall, Rockwall County, Texas,
63 zoned Single-Family 7 (SF-7) District, situated within the Old Town Rockwall (OTR) Historic District, addressed as 203 N. Clark Street, and take any action
64 necessary.

65
66
67
68
69
70
71
72
73
74
75
76
77
78
79
80
81
82
83
84
85
86
87
88
89
90
91
92
93
94
95
96
97
98
99
100
101
102
103
104
105
106
107
108
109
110
111
112
113
114
115
116
117
118
119
120
121
122
123
124
125
126
127
128
129
130
131

Director of Planning and Zoning Ryan Miller provided a brief summary in regards to the request. The applicant is requesting a small matching grant for the replacement of windows. The small matching grant program is not restricted to items that require building permits the only stipulation is that it has to be visible from the front. Where the windows are being replaced would make it an eligible case. The total eligible amount for this case would be \$500. We currently have \$5,000 in the grant fund and we have not used any for the physical year of 2024.

Chairman Miller opened the public hearing and asked anyone who wished to speak to come forward at this time; there being no one indicating such, Chairman Miller closed the public hearing and brought the item back to the Board for discussion or action.

McNeely asked how much money it would be.

Board member McNeely made a motion to approve H2023-014. Board member Lewis seconded the motion which passed by a vote of 4-2 with Chairman Miller and Board member Litton dissenting.

4. **H2023-015 (BETHANY ROSS)**

Hold a public hearing to discuss and consider a request by Morgan Edwards for the approval of a Building Permit Fee Waiver for the replacement of windows on a Non-Contributing Property being a 1150-acre tract of land identified as a portion of Block 22 of the F & M Addition, City of Rockwall, Rockwall County, Texas, zoned Single-Family 7 (SF-7) District, situated within the Old Town Rockwall (OTR) Historic District, addressed as 203 N. Clark Street, and take any action necessary.

Director of Planning and Zoning Ryan Miller provided a brief summary in regards to the request. This would be in regards to the same property. This is another relief program they have in place in the district. This allows contributing properties to come in and request 100% of their building permit fees waived and non-contributing properties up to 50% of their building permit fees to be waived. In this case the building permit fee would be \$50 and they would be eligible for 50% of that which would be a \$25 reimbursement.

Board member Frasier asked if a building inspector would go inspect it.

Chairman Miller opened the public hearing and asked anyone who wished to speak to come forward at this time; there being no one indicating such, Chairman Miller closed the public hearing and brought the item back to the Board for discussion or action.

Board member Gaskin made a motion to approve H2023-015. Board member McNeely seconded the motion which passed by a vote of 4-2 with Chairman Miller and Board member Frasier dissenting.

5. **H2023-016 (ANGELICA GUEVARA)**

Hold a public hearing to discuss and consider a request by Keith Green for the approval of a Certificate of Appropriateness (COA) for a Guest Quarters/Secondary Living Unit on a High Contributing Property being a 0.22-acre tract of land identified as Block 43A of the B. F. Boydston Addition, City of Rockwall, Rockwall County, Texas, zoned Single-Family 7 (SF-7) District, situated within the Old Town Rockwall (OTR) Historic District, addressed as 605 E. Washington Street, and take any action necessary.

Planning Technician Angelica Guevara provided a brief summary in regards to the request. The applicant is requesting a COA for a high-contributing property. They are requesting to construct a guest quarters/ secondary living unit on the subject property. The proposed structure will match the existing single-family home and be a total of 350 SF. The applicant has indicated that the structure will have a half bath making it a guest quarters/ secondary living unit. The applicant will need to submit for a Specific Use Permit (SUP). Should the HPAB approve the COA a recommendation will be forwarded to the Planning and Zoning Commission for the approval of an exception to allow secondary living unit/ guest quarters. Staff mailed out 31 notices to property owners and occupants within 200-feet of the subject property. At this time staff has received one (1) notice in favor of the request.

Chairman Miller opened the public hearing and asked anyone who wished to speak to come forward at this time; there being no one indicating such, Chairman Miller closed the public hearing and brought the item back to the Board for discussion or action.

Keith Green
605 E Washington Street
Rockwall TX 75087

Mr. Green came forward and provided additional details in regards to the request.

Board member Gaskin asked if the paint would be the same as the house.

Board member Frasier made a motion to approve H2023-016. Board member McNeely seconded the motion which passed by a vote of 6-0.

6. **H2023-017 (ANGELICA GUEVARA)**

Hold a public hearing to discuss and consider a request by Keith Green for the approval of a Small Matching Grant for a Guest Quarters/Secondary Living Unit on a High Contributing Property being a 0.22-acre tract of land identified as Block 43A of the B. F. Boydston Addition, City of Rockwall, Rockwall County, Texas, zoned Single-Family 7 (SF-7) District, situated within the Old Town Rockwall (OTR) Historic District, addressed as 605 E. Washington Street, and take any action necessary.

132 Planning Technician Angelica Guevara provided a brief summary in regards to the request. The applicant is eligible up to \$1,000 in matching funds.
133 The total evaluation of the project provided by the applicant will be \$20,000 dollars and it will qualify for a small matching grant of \$1,000 dollars.

134
135 Chairman Miller opened the public hearing and asked anyone who wished to speak to come forward at this time; there being no one indicating
136 such, Chairman Miller closed the public hearing and brought the item back to the Board for discussion or action.

137
138 **Keith Green**
139 **605 E Washington Street**
140 **Rockwall TX 75087**

141
142 **Mr. Green came forward and provided additional details in regards to the request.**

143
144 **Chairman Miller asked if he has a contractor and got an estimate.**

145
146 **Board member Gaskin made a motion to approve H2023-017. Board member Frasier seconded the motion which passed by a vote of 6-0.**
147

148 **7. H2023-018 (ANGELICA GUEVARA)**

149 Hold a public hearing to discuss and consider a request by Keith Green for the approval of a *Building Permit Fee Waiver* for a *Guest Quarters/Secondary*
150 *Living Unit* on a *High Contributing Property* being a 0.22-acre tract of land identified as Block 43A of the B. F. Boydston Addition, City of Rockwall, Rockwall
151 County, Texas, zoned Single-Family 7 (SF-7) District, situated within the Old Town Rockwall (OTR) Historic District, addressed as 605 E. Washington Street,
152 and take any action necessary.

153
154 Planning Technician Angelica Guevara provided a brief summary in regards to the request. The applicant is requesting approval of a building
155 permit fee waiver. The subject property being in a high-contributing area this case is eligible for 100% reduction under the program. The estimated
156 building permit fees for the project are \$236.25.

157
158 Chairman Miller opened the public hearing and asked anyone who wished to speak to come forward at this time; there being no one indicating
159 such, Chairman Miller closed the public hearing and brought the item back to the Board for discussion or action.

160
161 Board member McNeely made a motion to approve H2023-018. Board member Frasier seconded the motion which passed by a vote of 5-1.
162 Chairman Miller dissenting.

163
164 V.DISCUSSION ITEMS

165
166 *These items are for discussion between staff and the Historic Preservation Advisory Board (HPAB) and relate to administrative information and/or cases that*
167 *will come forward for action or public hearing at a future Historic Preservation Advisory Board meeting. Public comment on these cases can take place when*
168 *these items are considered for action by the Historic Preservation Advisory Board.*

169
170 (3) Update from Historic Preservation Officer (HPO) regarding historic projects. (RYAN MILLER)

171
172 **Director of Planning and Zoning Ryan Miller indicated that there are currently no ongoing historic projects.**

173
174 VI.ADJOURNMENT

175
176 **Chairman Miller adjourned the meeting at 7:00PM.**

177
178 PASSED AND APPROVED BY THE HISTORICAL PRESERVATION ADVISORY BOARD OF THE CITY OF ROCKWALL, TEXAS, THIS THE ____ DAY
179 OF _____ 2023.

180
181
182 _____
183 TIFFANY MILLER, CHAIRMAN

184
185
186 _____
187 ATTEST: MELANIE ZAVALA, PLANNING COORDINATOR

188
189



CITY OF ROCKWALL

HISTORIC PRESERVATION ADVISORY BOARD CASE MEMO

PLANNING AND ZONING DEPARTMENT

385 S. GOLIAD STREET • ROCKWALL, TX 75087

PHONE: (972) 771-7745 • EMAIL: PLANNING@ROCKWALL.COM

TO: Historic Preservation Advisory Board

DATE: November 16, 2023

APPLICANT: Michael Cheatham

CASE NUMBER: H2023-019; *Certificate of Appropriateness (COA) for an Addition at 603 E. Rusk Street*

SUMMARY

Hold a public hearing to discuss and consider a request by Michael Cheatham on behalf of Jake Rashell and Nicole Smith for the approval of a Certificate of Appropriateness (COA) for an addition to an existing single-family home being a *Low Contributing Property* on a 0.25-acre parcel of land identified as Block 120E of the B. F. Boydston Addition, City of Rockwall, Rockwall County, Texas, zoned Single-Family 7 (SF-7) District, situated within the Old Town Rockwall (OTR) Historic District, addressed as 603 E. Rusk Street, take any action necessary.

BACKGROUND

According to the *2017 Historic Resource Survey*, the subject property is classified as a *Low-Contributing Property*. The 926 SF single-family home -- situated on the subject property at 603 E. Rusk Street -- was constructed circa 1950 with *Craftsman* style influences. The subject property is a part of the Old Town Rockwall (OTR) Historic District, and was annexed prior to 1900 based on the October 1900 Sanborn Maps. According to Rockwall Central Appraisal District (RCAD), there is a covered porch and an 80 SF storage building that were constructed on the subject property in 2008. The *2017 Historic Resource Survey* states that the windows and doors have been replaced on the existing single-family home. There was a rear addition that is also listed; however, the date of this addition is unknown.



SUBJECT PROPERTY: AUGUST 17, 2012

PURPOSE

The applicant is requesting approval of a Certificate of Appropriateness (COA) for an addition to the existing single-family home on the subject property.

ADJACENT LAND USES AND ACCESS

The subject property is located at 603 E. Rusk Street. The land uses adjacent to the subject property are as follows:

North: Directly north of the subject property are two (2) parcels of land located within the Old Town Rockwall Historic District (*i.e. 102 N. Tyler Street and 604 E. Kaufman Street*). According to the *2017 Historic Resource Survey*, these properties are classified as *Medium Contributing* properties. Beyond this is E. Kaufman Street, which is identified as a A4D (*i.e. major arterial, four [4] lane, divided roadway*) on the Master Thoroughfare Plan contained in the OURHometown Vision 2040 Comprehensive Plan. Beyond this are two (2) parcels of land (*i.e. 601 & 605 E. Kaufman Street*) located within the Old Town Rockwall Historic District. According to the *2017 Historic Resource Survey*, these properties are classified as *Non-Contributing* properties.

South: Directly south of the subject is E. Rusk Street, which is identified as a A4D (*i.e. major arterial, four [4] lane, divided roadway*) on the City's Master Thoroughfare Plan contained in the OURHometown Vision 2040 Comprehensive Plan. Beyond this are five (5) parcels of land (*i.e. 602, 604, 606, 608, 610 E. Rusk Street*) located within the Old

Town Rockwall Historic District. According to the 2017 *Historic Resource Survey*, all of these properties are classified as *Medium Contributing* properties. South of this are four (4) parcels of land (i.e. 601, 605, 609 E. Washington Street & 106 S. Clark Street) located within the Old Town Historic District. Three (3) of these properties (i.e. 601, 609 E. Washington Street & 106 S. Clark Street) are classified as *Medium Contributing* and the remaining (i.e. 605 E. Washington Street) is classified as a *High Contributing* property.

East: Directly east of the subject property are three (3) parcels of land (i.e. 605, 609 & 611 E. Rusk Street) located within the Old Town Historic District. Two (2) of these properties (i.e. 605 & 611 E. Rusk Street) are classified as *Low Contributing* and the remaining parcel (i.e. 609 E. Rusk Street) is classified as *Medium Contributing*. Beyond this is S. Clark Street, which is identified as a *Minor Collector* on the Master Thoroughfare Plan contained in the OURHometown Vision 2040 Comprehensive Plan. East of this roadway is a 1.503-acre parcel of land with a ~2,895 single-family home (i.e. 104 N. Clark Street) that was constructed in 1995 situated on it. This structure is classified as *High Contributing*.

West: Directly west of the subject property is a 0.1726-acre parcel of land with a ~1,744 single-family home (i.e. 601 E. Rusk Street) that was constructed in 1985 situated on it. This structure is classified as *Medium Contributing*. Beyond this is N. Tyler Street, which is indicated as a R2 (i.e. residential, two [2] lane, undivided roadway) on the Master Thoroughfare Plan contained in the OURHometown Vision 2040 Comprehensive Plan. West of this is a 0.4590-acre parcel of land with a ~3,557 single-family home (i.e. 507 E. Rusk Street) that was constructed in 1920 situated on it. This structure is classified as *Medium Contributing*.

CHARACTERISTICS OF THE PROJECT

The applicant is proposing to construct roughly 615 SF of air-conditioned space to the back of the existing single-family home. The additional space will consist of 375 SF of additional living room space and 240 SF that will be a bedroom and closet. The applicant is also proposing to add a 400 SF, two (2) car garage to the right side of the home. The applicant has indicated that the new exterior façades will match the existing single-family home with the exception of the hardie board siding on the back of the addition. Staff should note that the proposed hardie board siding on the back addition will not be visible from the street.

CONFORMANCE TO THE HISTORIC DISTRICT GUIDELINES & CITY'S CODES

According to Subsection 06.03(F), *Certificate of Appropriateness (COA) for Alteration or New Construction*, of Article 05, *District Development Standards*, of the Unified Development Code (UDC), "(t)he provisions of this ordinance [*Historic Overlay (HOV) District*] shall apply only to those properties ... which meet the following criteria: [1] either be a designed historical landmark or be wholly or partially located within a designated historic district, and [2] either be a contributing property as defined by *Subsection B* or be located within 200-feet of a contributing property." In this case, the subject property meets all of the criteria for a property that would require a Certificate of Appropriateness (COA). Specifically, it is situated wholly within the Old Town Rockwall (OTR) Historic District, and is designated as a *Low Contributing Property*.

Staff should note that the Historic Preservation Advisory Board (HPAB) has the ability to review the proposed exterior changes and cannot consider interior remodel work. In reviewing the applicant's request against Section 07, *Building Standards*, of Appendix D, *Historic Preservation Guidelines*, of the Unified Development Code (UDC) the following guidelines apply:

(1) Building Standards.

- (a) Height. According to Section 07(A), of Appendix D, *Historic Preservation Guidelines*, of the Unified Development Code (UDC), "(a)ll new buildings and additions shall be constructed to a height and number of stories which are consistent and compatible with existing neighboring historic buildings or structures on the same block face." In this case, the proposed addition and the proposed garage will be leveled with the existing single-family home and have a total height of 14-feet, 10½-inches.
- (b) Building Setback and Orientation. According to Section 07(B)(1), of Appendix D, *Historic Preservation Guidelines*, of the Unified Development Code (UDC), "(a)ll new additions, alterations, infill and new infill construction should recognize and maintain the established historic home site orientation, and side and front side setbacks within the block face, thereby being visually compatible and maintaining the established rhythm and setback spacing." Based on the

applicant's building plans, the proposed addition and the new garage will still be in conformance with the required setbacks for a structure in a Single-Family 7 (SF-7) District.

- (c) Building Facades and Materials. According to Section 07(C)(6), of Appendix D, *Historic Preservation Guidelines*, of the Unified Development Code (UDC), "(n)ew additions, alterations and new construction should be visually compatible with neighboring historic buildings or structures." Based on the building elevations and scope of work provided by the applicant, the exterior façade of the new addition will consist of the same material that the existing single-family home is faced in with the exception of the proposed hardie board siding in the back of the home.
- (d) Roofs. According to Section 07(M), of Appendix D, *Historic Preservations Guidelines*, of the Unified Development Code (UDC), "(r)eplacement, addition, or alteration to an existing roof should have the same overhang as the existing roof." The code goes on to say "(t)he degree and direction of roof slope or pitch should be consistent with the style and period of the historic structure." In this case, the applicant's plans show a consistent roof pitch of 5:12 throughout the proposed addition. In addition, the exposed rafters on the new additions being consistent with the placement on the existing single-family home.
- (e) Paint and Color. According to Section 07(M), of Appendix D, *Historic Preservations Guidelines*, of the Unified Development Code (UDC), "(b)rick, stone or other naturally or historically unpainted materials should not be painted unless the material has been painted before." In this case, the existing home has been previously painted and does not require the approval of the Historic Preservation Advisory Board (HPAB); however, the applicant has indicated to staff that they intend to paint the addition and garage the same color as the existing single-family home, to create a consistent look. Staff should note that the HPAB does not have discretion over this aspect of the case, unless, as mentioned previously, the material has not been painted before; however, the *Historic Preservation Guidelines* discourage "(f)lorescent and metallic colors."

According to Subsection 06.03(G)(5), *Standards of Approval*, of Article 05, *District Development Standards*, of the Unified Development Code (UDC), "the Historic Preservation Advisory Board (HPAB) must approve the application for a Certificate of Appropriateness if it determines that ... the application will not adversely affect the character of the site; and the proposed work is consistent with the regulations contained in this section [*i.e.*] and proposed preservation criteria ..." While the proposed additions do not appear to impair the historical integrity of the subject property nor negatively impact the adjacent properties, approval of a Certificate of Appropriateness (COA) is a discretionary decision for the Historic Preservation Advisory Board (HPAB).

NOTIFICATIONS

On November 2, 2023, staff mailed 32 property owner notifications to property owners and occupants within 200-feet of the subject property. At the time this report was drafted, staff had not received any notices returned regarding the applicant's request.

CONDITIONS OF APPROVAL

If the Historic Preservation Advisory Board (HPAB) chooses to approve the request for a *Certificate of Appropriateness (COA)*, staff would propose the following conditions of approval:

- (1) The applicant shall be required to receive the necessary building permit(s) prior to any construction on the subject property.
- (2) Any construction resulting from the approval of this request shall conform to the requirements set forth by the Unified Development Code (UDC), the International Building Code (IBC), the Rockwall Municipal Code of Ordinances, city adopted engineering and fire codes and with all other applicable regulatory requirements administered and/or enforced by the state and federal government.



HISTORIC PRESERVATION ADVISORY BOARD APPLICATION

City of Rockwall
Planning and Zoning Department
385 S. Goliad Street
Rockwall, Texas 75087

STAFF USE ONLY

CASE NUMBER: _____

NOTE: THE APPLICATION IS NOT CONSIDERED ACCEPTED BY THE CITY UNTIL THE PLANNING DIRECTOR HAS SIGNED BELOW.

DIRECTOR OF PLANNING: _____

DATE RECEIVED: _____

RECEIVED BY: _____

APPLICATION:

- CERTIFICATE OF APPROPRIATENESS (COA)
- LOCAL LANDMARK EVALUATION & DESIGNATION
- BUILDING PERMIT WAIVER & REDUCTION PROGRAM
- SMALL MATCHING GRANT APPLICATION

SPECIAL DISTRICTS [SELECT APPLICABLE]:

- OLD TOWN ROCKWALL HISTORIC (OTR) DISTRICT
- PLANNED DEVELOPMENT DISTRICT 50 (PD-50)
- SOUTHSIDE RESIDENTIAL NEIGHBORHOOD OVERLAY (SRO) DISTRICT
- DOWNTOWN (DT) DISTRICT

CONTRIBUTING STATUS [SELECT APPLICABLE]:

- LANDMARKED PROPERTY
- HIGH CONTRIBUTING PROPERTY
- MEDIUM CONTRIBUTING PROPERTY
- LOW CONTRIBUTING PROPERTY
- NON-CONTRIBUTING PROPERTY

CURRENT LAND USE OF THE SUBJECT PROPERTY:

- RESIDENTIAL
- COMMERCIAL

PROPERTY INFORMATION [PLEASE PRINT]

ADDRESS 603 EAST RUSK ST ROCKWALL TX 75087

SUBDIVISION _____ LOT _____ BLOCK _____

OWNER/APPLICANT/AGENT INFORMATION [PLEASE PRINT/CHECK THE PRIMARY CONTACT/ORIGINAL SIGNATURES ARE REQUIRED]

IS THE OWNER OF THE PROPERTY THE PRIMARY CONTACT? YES NO

APPLICANT(S) IS/ARE: OWNER TENANT NON-PROFIT RESIDENT

CHECK THIS BOX IF OWNER AND APPLICANT ARE THE SAME.

OTHER, SPECIFY: _____

OWNER(S) NAME JAKE RASHELL / NICOLE SMITH

APPLICANT(S) NAME MICHAEL CHEATHAM

ADDRESS 603 EAST RUSK ST ROCKWALL

ADDRESS 1821 TRAIL DR ROCKWALL TX

PHONE 972-750-8802 / 208-791-9225

PHONE 469-734-6055

E-MAIL JAVERASHELL@GMAIL.COM
SMITHNCL01@GMAIL.COM

E-MAIL OFFICE@WILLOWCREEKCUSTOMHOMES.COM

SCOPE OF WORK/REASON FOR EVALUATION REQUEST [PLEASE PRINT]

CONSTRUCTION TYPE [CHECK ONE]:

- EXTERIOR ALTERATION
- NEW CONSTRUCTION
- ADDITION
- DEMOLITION
- RELOCATIONS
- OTHER, SPECIFY: _____

ESTIMATED COST OF CONSTRUCTION/DEMOLITION OF THE PROJECT (IF APPLICABLE): \$ 120,000

PROJECT DESCRIPTION. IN THE SPACE PROVIDED BELOW OR ON A SEPARATE SHEET OF PAPER, DESCRIBE IN DETAIL THE WORK THAT WILL BE PERFORMED ON SITE. FOR LOCAL LANDMARK EVALUATION & DESIGNATION REQUESTS INDICATE ANY ADDITIONAL INFORMATION YOU MAY HAVE CONCERNING THE PROPERTY, HISTORY, SIGNIFICANCE, PRESENT CONDITIONS, STATUS, CURRENT OR PAST USE(S), ETC. STAFF RECOMMENDS THAT PHOTOGRAPHS OF THE INTERIOR AND EXTERIOR OF THE PROPERTY ARE SUBMITTED WITH THIS APPLICATION.

ADDING ROUGHLY 615 SF OF AIR CONDITIONED SPACE TO BACK OF HOME. 375 SF TO BE LIVING ROOM & 240 SF TO BE BEDROOM & CLOSET. ADDING A 400 SF 2 CAR GARAGE TO RIGHT SIDE OF HOME. ALL NEW EXTERIOR FACADE TO MATCH EXISTING EXCEPT POSSIBLY USING A HARDY SIDING ON BACK NOT EXPOSED TO STREET IF ALLOWED.

OWNER & APPLICANT STATEMENT [ORIGINAL SIGNATURES REQUIRED]

I ACKNOWLEDGE THAT I HAVE READ THIS APPLICATION AND THAT ALL INFORMATION CONTAINED HEREIN IS TRUE AND CORRECT TO THE BEST OF MY KNOWLEDGE. FURTHERMORE, I UNDERSTAND THAT IT IS NECESSARY FOR ME OR A REPRESENTATIVE TO BE PRESENT AT A PUBLIC HEARING FOR THIS CASE TO BE APPROVED.

OWNER'S SIGNATURE _____

APPLICANT'S SIGNATURE [Signature]



H2023-019: Certificate of Appropriateness for 603 E Rusk



Case Location Map = 



City of Rockwall

Planning & Zoning Department
385 S. Goliad Street
Rockwall, Texas 75087
(P): (972) 771-7745
(W): www.rockwall.com

The City of Rockwall GIS maps are continually under development and therefore subject to change without notice. While we endeavor to provide timely and accurate information, we make no guarantees. The City of Rockwall makes no warranty, express or implied, including warranties of merchantability and fitness for a particular purpose. Use of the information is the sole responsibility of the user.





City of Rockwall

Planning & Zoning Department
385 S. Goliad Street
Rockwall, Texas 75087
(P): (972) 771-7745
(W): www.rockwall.com

The City of Rockwall GIS maps are continually under development and therefore subject to change without notice. While we endeavor to provide timely and accurate information, we make no guarantees. The City of Rockwall makes no warranty, express or implied, including warranties of merchantability and fitness for a particular purpose. Use of the information is the sole responsibility of the user.

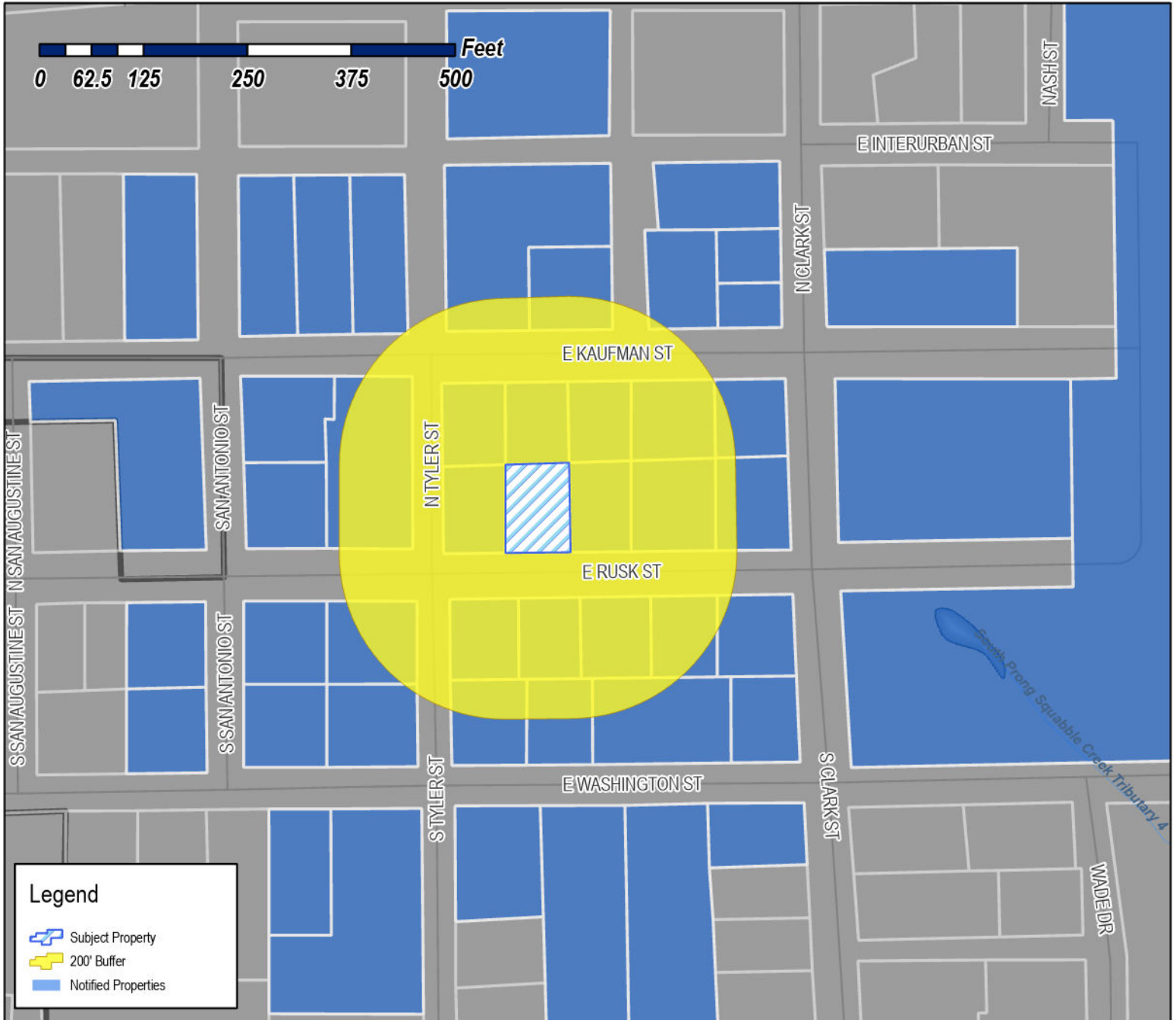

Case Number: H2023-019
Case Name: Certificate of Appropriateness for 603 E Rusk Street
Case Type: Historic
Zoning: Single-Family 7 (SF-7) District
Case Address: 603 E Rusk Street

Date Saved: 10/30/2023

For Questions on this Case Call: (972) 771-7746

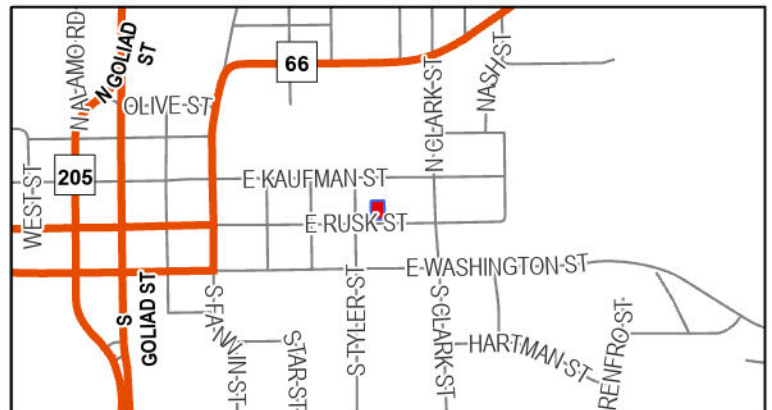

SMILEY KAREN APRIL
605 E RUSK ST
ROCKWALL, TX 75087

INDEPENDENT ADMINISTRATOR - ESTATE OF
ROBERT THOMAS WIKTORCH
P.O. BOX 3061
WARMINSTER, PA 18974

DUTT JOHN RICHARD JR ETUX
505 E WASHINGTON ST
ROCKWALL, TX 75087

BIRKENBACK JOSSEPH M & OLGA M
506 E RUSK ST
ROCKWALL, TX 75087

CLARK JENNIFER A
610 E KAUFMAN ST
ROCKWALL, TX 75087

GALVAN CARMAN
604 E KAUFMAN ST
ROCKWALL, TX 75087

OCCUPANT
603 E RUSK ST
ROCKWALL, TX 75087

INTEGRITY ALL CASH HOME BUYERS LLC
7340 BAKER BLVD #392
RICHLAND HILLS, TX 76118

ROCKWALL COMMUNITY PLAYHOUSE
609 E RUSK ST
ROCKWALL, TX 75087

OCCUPANT
601 E WASHINGTON ST
ROCKWALL, TX 75087

GLASS JERRY
301 MEADOWDALE DR
ROCKWALL, TX 75087

GREEN JAMES KEITH II & HOLLY NICOLE
605 E WASHINGTON ST
ROCKWALL, TX 75087

ROCKWALL COMMUNITY PLAYHOUSE
609 E RUSK ST
ROCKWALL, TX 75087

REEVES ASHLEY ELLEN & DANIEL GARRET
609 E WASHINGTON ST
ROCKWALL, TX 75087

WEBB RODNEY D AND FRAN W
507 E RUSK ST
ROCKWALL, TX 75087

HARPER VICKI DAWSON
605 E KAUFMAN ST
ROCKWALL, TX 75087

OCCUPANT
601 E KAUFMAN ST
ROCKWALL, TX 75087

HARPER LYDIA
1200 CLEVELAND STREET APT 327
DENTON, TX 76201

HARPER VICKI DAWSON
605 E KAUFMAN ST
ROCKWALL, TX 75087

ROCKWALL COMMUNITY PLAYHOUSE
609 E RUSK ST
ROCKWALL, TX 75087

COUNTY OF ROCKWALL
101 E Rusk ST
ROCKWALL, TX 75087

WILLIAMS JERRY LANE
608 E RUSK ST
ROCKWALL, TX 75087

SMITH GREGORY P & MARILYN
610 E RUSK ST
ROCKWALL, TX 75087

ROBINSON NELDA
602 E RUSK ST
ROCKWALL, TX 75087

HORNER ANDREA J
604 E RUSK ST
ROCKWALL, TX 75087

OCCUPANT
102 S CLARK ST
ROCKWALL, TX 75087

KINSEY DONALD H & TARI L
2 MANOR COURT
HEATH, TX 75032

OCCUPANT
601 E RUSK ST
ROCKWALL, TX 75087

QUINTON BILLY & AUTUMN
102 N TYLER ST
ROCKWALL, TX 75087

QUINTON BILLY & AUTUMN
102 N TYLER ST
ROCKWALL, TX 75087

OCCUPANT
505 E KAUFMAN ST
ROCKWALL, TX 75087

BALL JUSTIN
2155 CLUBVIEW DR
ROCKWALL, TX 75087

PUBLIC NOTICE



CITY OF ROCKWALL
PLANNING AND ZONING DEPARTMENT
PHONE: (972) 771-7745
EMAIL: PLANNING@ROCKWALL.COM

Property Owner and/or Resident of the City of Rockwall:

You are hereby notified that the Historic Preservation Advisory Board will consider the following application:

Case No. H2023-019: Certificate of Appropriateness for 603 E. Rusk Street

Hold a public hearing to discuss and consider a request by Michael Cheatham on behalf of Jake Rashell and Nicole Smith for the approval of a Certificate of Appropriateness (COA) for an addition to an existing single-family home being a Low Contributing Property on a 0.25-acre parcel of land identified as Block 120E of the B. F. Boydston Addition, City of Rockwall, Rockwall County, Texas, zoned Single-Family 7 (SF-7) District, situated within the Old Town Rockwall (OTR) Historic District, addressed as 603 E. Rusk Street, take any action necessary.

For the purpose of considering the effects of such a request, the Historic Preservation Advisory Board will hold a public hearing on Thursday, November 16, 2023 at 6:00 PM. This hearing will be held in the City Council Chambers at City Hall, 385 S. Goliad Street.

As an interested property owner, you are invited to attend these meetings. If you prefer to express your thoughts in writing please return the form to:

Angelica Guevara
Rockwall Planning and Zoning Dept.
385 S. Goliad Street
Rockwall, TX 75087

You may also email your comments to the Planning Department at planning@rockwall.com. If you choose to email the Planning Department please include your name and address for identification purposes.

Your comments must be received by Thursday, November 16, 2023 at 4:00 PM to ensure they are included in the information provided to the Historic Preservation Advisory Board.

Sincerely,

Ryan Miller, AICP
Director of Planning & Zoning

----- PLEASE RETURN THE BELOW FORM -----

Case No. H2023-019: Certificate of Appropriateness for 603 E. Rusk Street

Please place a check mark on the appropriate line below:

I am in favor of the request for the reasons listed below.

I am opposed to the request for the reasons listed below.

Four horizontal grey bars for providing reasons for support or opposition.

Name:

Grey bar for Name

Address:

Grey bar for Address

Tex. Loc. Gov. Code, Sec. 211.006 (d) If a proposed change to a regulation or boundary is protested in accordance with this subsection, the proposed change must receive, in order to take effect, the affirmative vote of at least three-fourths of all members of the governing body. The protest must be written and signed by the owners of at least 20 percent of either: (1) the area of the lots or land covered by the proposed change; or (2) the area of the lots or land immediately adjoining the area covered by the proposed change and extending 200 feet from that area.

PLEASE SEE LOCATION MAP OF SUBJECT PROPERTY ON THE BACK OF THIS NOTICE



TRACT 2
BILLY QUINTON AND
AUTUMN QUINTON
INST. NO.
20160000012152

CARMEN GALVAN
VOL. 1907, PG. 137

(CM)
N.E. CORNER OF
CARMEN GALVAN
VOL. 1907, PG. 137

VICTORY WORSHIP
CENTER, INC.
VOL. 1395, PG. 142

1/2" IRF FOR REFERENCE
S 01°31'27" E - 0.38'

N 89°44'24" E 75.00'

100.00'

N 01°31'27" W

100.00'

TRACT 1
BILLY QUINTON AND
AUTUMN QUINTON
INST. NO.
20160000012152

7,498 sq. ft.
0.17 of an acre

ONE STORY
FRAME NO
FOUNDATION

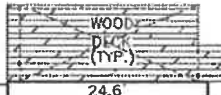

ONE STORY
FRAME
(603)

ROBERT THOMAS
WIKTORCHIK
INST. NO.
2007-00381305

(CM)
S.W. CORNER OF
TRACT 1
BILLY QUINTON AND
AUTUMN QUINTON
INST. NO.
20160000012152

75.00'

S 89°44'24" W 75.00'

PLACE OF
BEGINNING

OHPL OHPL OHPL OHPL OHPL

ASPHALT

E. RUSK STREET



TRACT 2
BILLY QUINTON AND
AUTUMN QUINTON
INST. NO.
20160000012152

CARMEN GALVAN
VOL. 1907, PG. 137

VICTORY WORSHIP
CENTER, INC.
VOL. 1395, PG. 142

1/2" IRF FOR REFERENCE
S 01°31'27" E - 0.38'

(CM)
N.E. CORNER OF
CARMEN GALVAN
VOL. 1907, PG. 137

TRACT 1
BILLY QUINTON AND
AUTUMN QUINTON
INST. NO.
20160000012152

ROBERT THOMAS
WIKTORCHIK
INST. NO.
2007-00381305

(CM)
S.W. CORNER OF
TRACT 1
BILLY QUINTON AND
AUTUMN QUINTON
INST. NO.
20160000012152

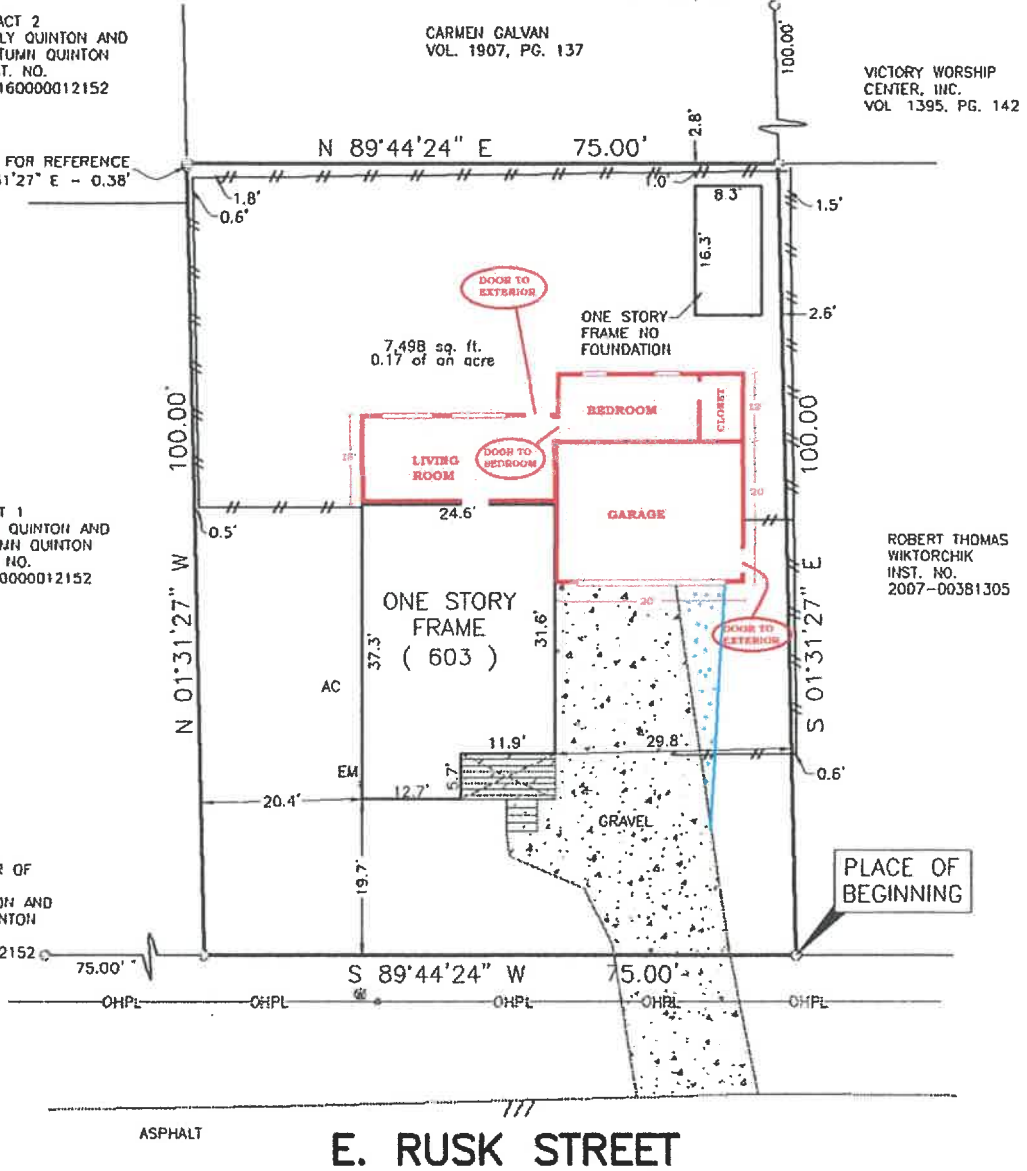



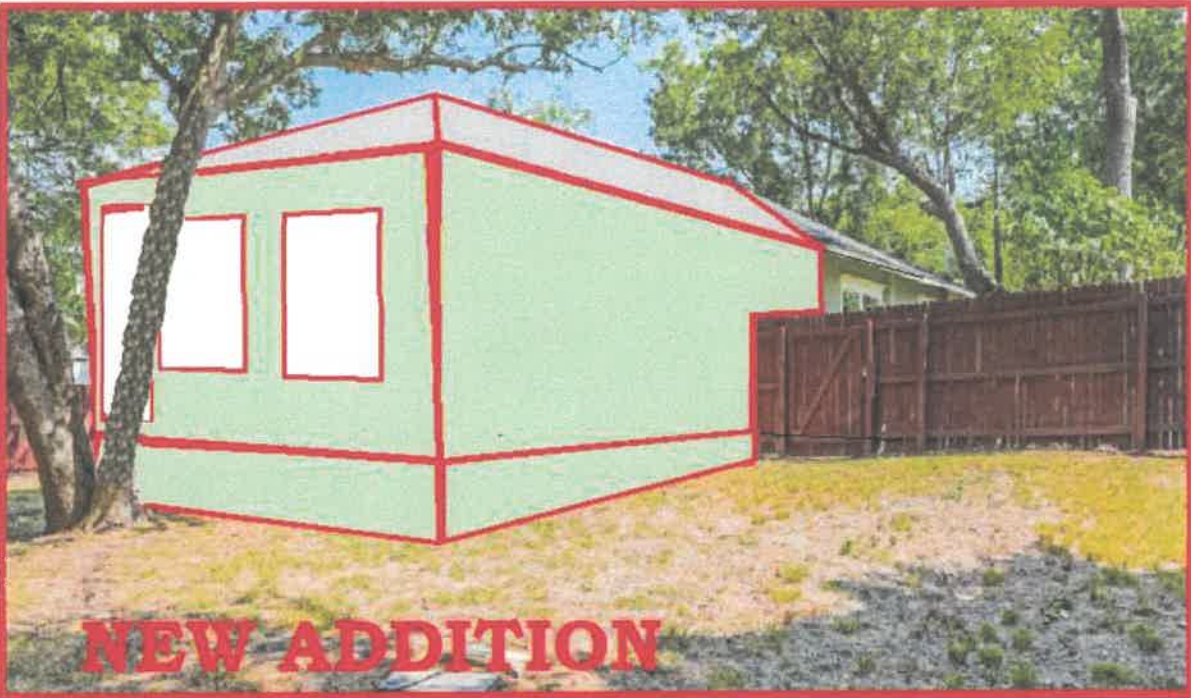

NEW ADDITION



EXISTING

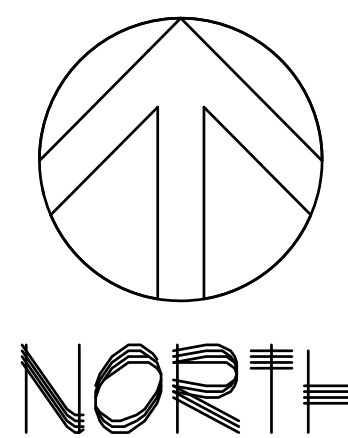
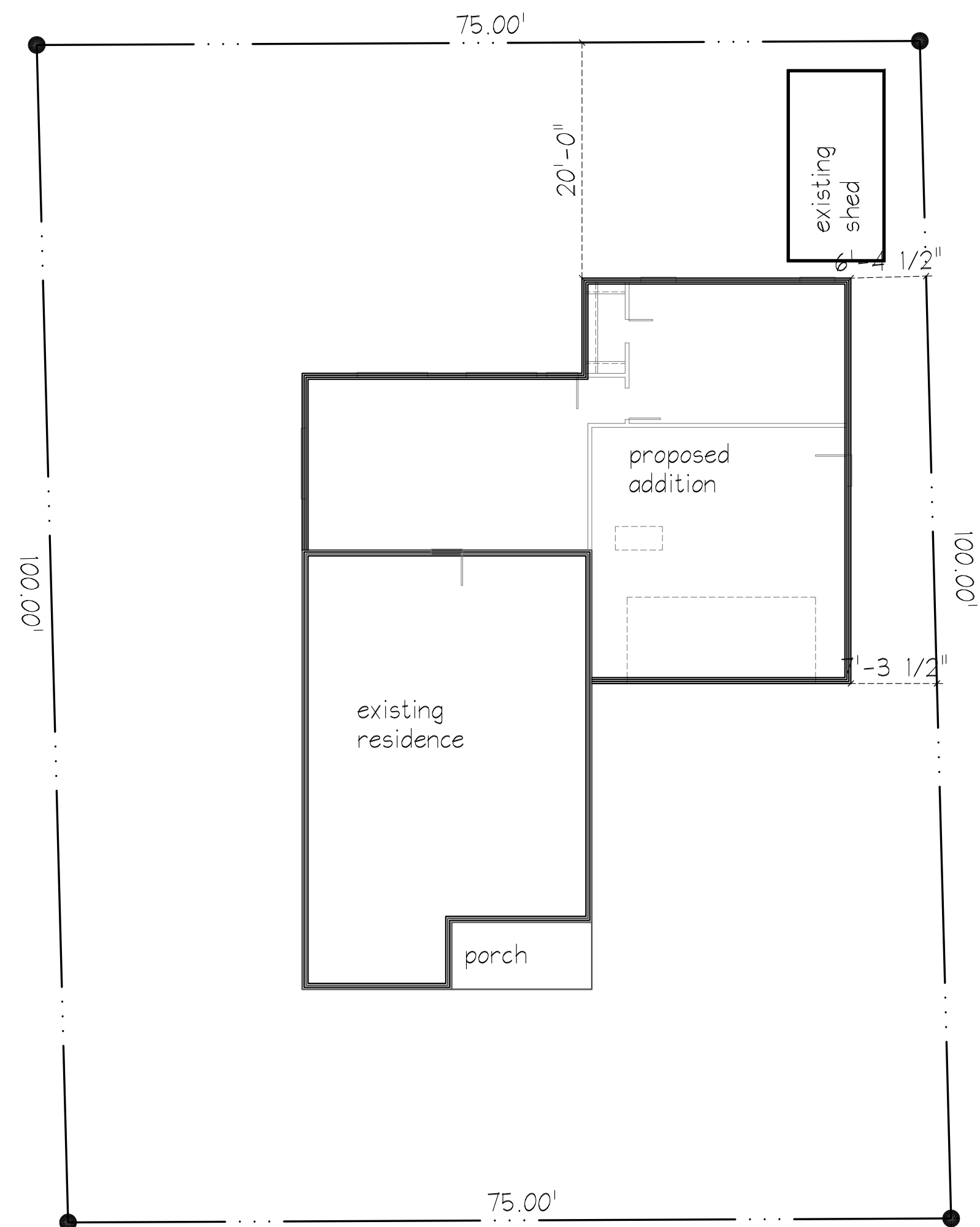

Areas:

Area of Lot	7,498 sq. ft.
Covered Area	1,142 sq. ft.
Percent Covered	15.2%

PLOT PLAN

SCALE 1" = 10'-0"

Notes:

- Do not scale drawings, follow dimensions only. All structural information shown for reference purposes only. Contractor shall have licensed structural engineer review and design all structural elements such as all framing walls, beams, connections, headers, joists and rafters.
- All dimensions are from face of stud to face of stud unless otherwise noted.
- Window sizes indicated on plans are noted by approximate rough openings size. Verify window sizes and "owner furnish windows" with owner prior to construction. Refer to plans and exterior elevations for window types.
- All framing shall be done in accordance with IBC latest edition.
- Spread studs at tub ends to accommodate plumbing and provide blocking, top and bottom, at shower to secure plumbing.
- Exterior sheathing shall be 5/8" OSB.
- All interior walls shall be covered with 1/2" gypsum board with metal corner reinforcing. Drywall finish should include taping over joints, applying joint compound and sanding the compound for a smooth finish. Verify with owner the level of drywall texturing.
- All walls and ceilings in garage and garage storage areas to have 5/8" Type-X gypsum board with 1-hour fire rating. All exterior doors in garage and attic access to be metal or solid core with a 20 minute fire rating.
- Provide 1/2" "moisture resistant" gypsum board at all wet locations.
- All finishes to be chosen and verified by owner.
- Contractor shall field verify all cabinet dimensions before fabrication.
- All millwork to be chosen and verified by owner. Contractor shall submit "shop drawings" at owners request.
- Provide 1/2" cement board for tile backer.
- Provide min. 4 - gang 2x4 studs at glue-lam bearing.
- All work shall be in accordance with National Plumbing Code, Latest Edition.
- Contractor shall provide HVAC "duct layout" for approval prior to fabrication. For coordination with fixtures and diffuser location.
- Verify all column type, size, and material with owner prior to construction.
- Prefabricated fireplace construction shall meet or exceed all applicable codes regarding use of fire separations, clearances, etc. It is the contractor's responsibility to ensure that all items and construction meet or exceed code. Overall flue height shall be coordinated to match height shown on plans and shall not exceed the top of chimney chase as constructed. All fireplace chase walls shall be insulated inside and outside. Provide horizontal "draft stops" at each floor level by packing 6" (R19) insulation between 2x4 joists.
- Provide combustion air vents with screen and back damper for fireplaces, wood stoves and any appliance with an open flame.
- All bath and toilet area walls shall have water resistant gypsum boards.
- All plumbing walls shall be 2x6.
- Bedroom windows shall have a minimum net clear opening of 5.7 square feet, a minimum net clear openable width of 20", a minimum net clear openable height of 24", and have a maximum finish sill height of 42" from finished floor. All glass located within 18" of floor, 24" of a door or located within 60" of floor at bath tubs, whirlpools, showers, saunas, steam rooms, or hot tubs shall be tempered.
- Attic HVAC units shall be located within 20' of its service opening. Return air grills shall not be located within 10' of a gas fired appliance.
- All exposed insulation shall have a flame spread rating of less than 25 and a smoke density rating of less than 450.

MASTER REVISION INDEX

SHEET #	DESCRIPTION	SCALE
1	PLOT PLAN	1"=10'-0"
2	DEMO PLAN & REMODEL PLAN W/ ELECTRICAL	1/4"=1'-0"
3	FOUNDATION LAYOUT & ROOF PLAN	1/4"=1'-0"
4	FRONT, REAR, LEFT, & RIGHT ELEVATION	1/4"=1'-0"
5	STANDARD DETAILS	N.T.S.

APPLICABLE CODES

- 2021 INTERNATIONAL FIRE CODE
- 2021 INTERNATIONAL BUILDING CODE
- 2021 INTERNATIONAL PLUMBING CODE
- 2020 NATIONAL ELECTRICAL CODE
- 2021 INTERNATIONAL RESIDENTIAL CODE
- 2021 INTERNATIONAL ENERGY CONSERVATION CODE
- 2021 INTERNATIONAL FUEL & GAS CODE
- 2021 INTERNATIONAL GREEN CONSTRUCTION CODE

REVISIONS:

11/02/2023

J. Karlovich
Home Design

(214) 674-0290 : Phone
jkarlovichhomedesign.com

These plans are intended to provide the basis construction information necessary to substantially complete the structure. Like most home designers, this firm, J. Karlovich Home Design, is not being an architectural or engineering firm stands no liability for structural or architectural design integrity. Every effort has been made to ensure all dimensions are correct and governmental regulations have been met. If any error or omission does occur it is the sole responsibility of the contractor and/or the owner to correct the error and/or omission at his own expense and not the responsibility of J. Karlovich Home Design. These plans are intended to be a one-time use for this address ONLY.

Willow Creek Custom Homes
469-338-0141

A Custom Addition for:
Jake Rashell & Nicole Smith

603 E Rusk Street
Abstract No. 14
B.F. Boydston Survey
City of Rockwall, Rockwall County, Texas

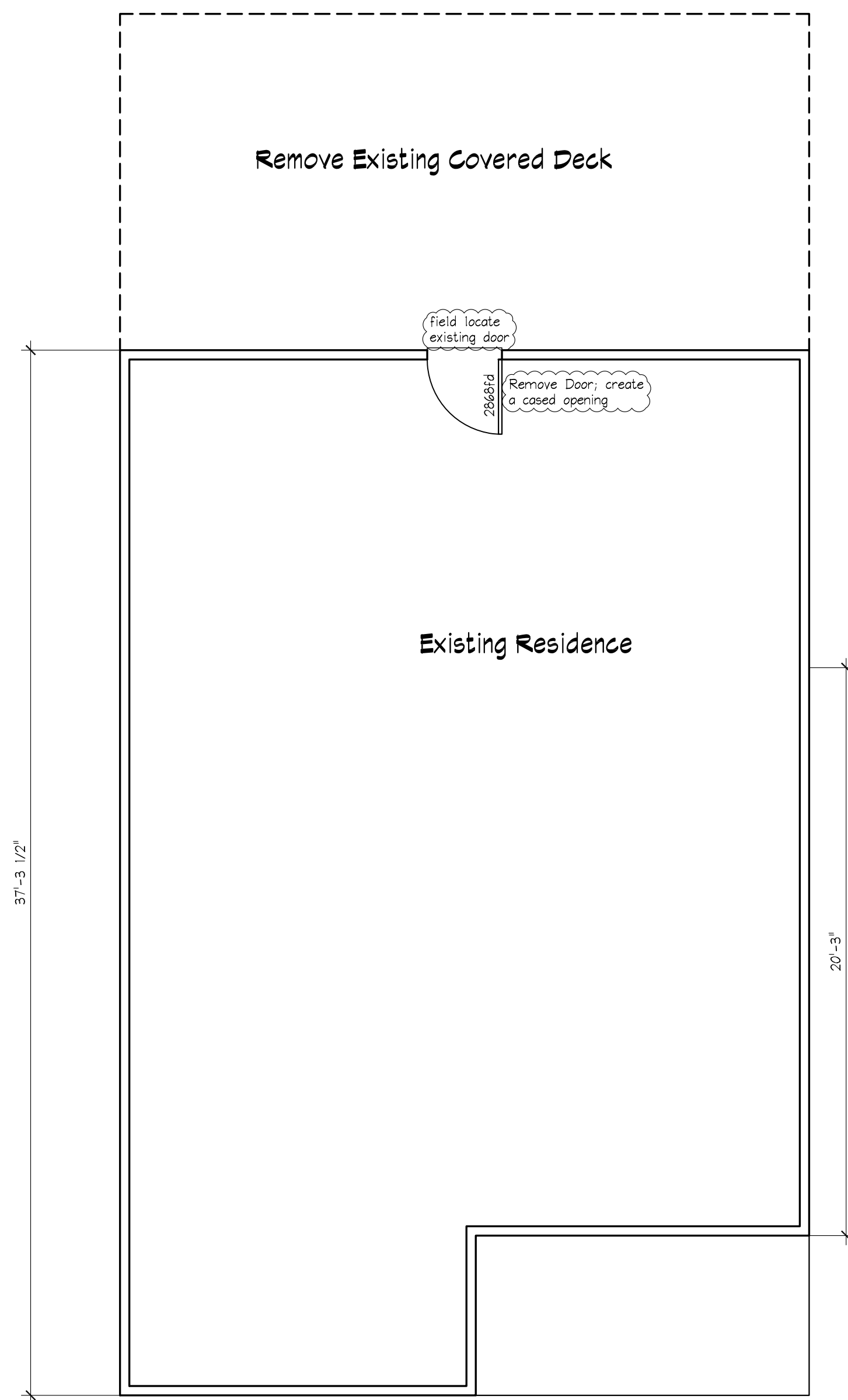

EXISTING + DEMO PLAN

SCALE 1/4" = 1'-0"

ELECTRICAL LEGEND

- ⊕ Surface/Ceiling Mount
- ⊙ Recessed Eyeball Mount
- ⊕ Ground-up Landscape Flood
- ⊕ Wall Mounted
- ⊕ 6" LED Recessed Can Light
- ⊕ 6" Vapor Recessed Can Light
- ⊕ Single Fluorescent Strip
- ⊕ Double Flood w/ Motion Sensor (exterior)
- ⊕ LED Fluorescent Lighting
- ⊕ Exhaust Fan (minimum 90 cfm)
- ⊕ Ceiling Heater
- ⊕ Carbon Monoxide Detector
- ⊕ Sub Panel
- ⊕ Intercomm System
- ⊕ Telephone Jack
- ⊕ Bundled Cable (2 RG6 Coax, 2 CAT6, 2 Fiber)
- ⊕ Network (CAT6 Only)
- ⊕ Speaker (1/4 Speaker Wiring)
- ⊕ Smoke and Carbon Monoxide Detector
- ⊕ Duplex Outlet (125 volt)
- ⊕ Appliance Outlet (240 volt)
- ⊕ GFI Outlet (UL Approved)
- ⊕ Ceiling Outlet (125 volt)
- ⊕ Floor Outlet (pre-wire before pouring foundation)
- ⊕ Single Light Switch
- ⊕ Three Way Light Switch
- ⊕ Light Switch with Dimmer Control
- ⊕ Ceiling Fan (provide proper ceiling brace)
- ⊕ Electrical Breaker Box (refer to electrician for size)

Notes:

1. All electrical work shall be done in accordance with National Electric Code, Latest Edition.
2. Provide a J-Box below counter for dishwasher, ice machine, compactor and range.
3. Provide waterproof covers on all exterior outlets and ground fault interrupter receptacles in all wet and exterior locations.
4. All fixtures shall be UL Approved.
5. Provide "buzzer" at entry doors and door chimes.
6. Verify water heater and HVAC electrical requirements prior to construction.
7. Verify all outlet, switch, fixture, television and telephone locations with owner prior to construction.
8. Provide light fixtures and outlets in attic as per owners instructions.
9. Verify all light fixtures and plug type and location with owner prior to installation.
10. Center all light fixtures in each room.

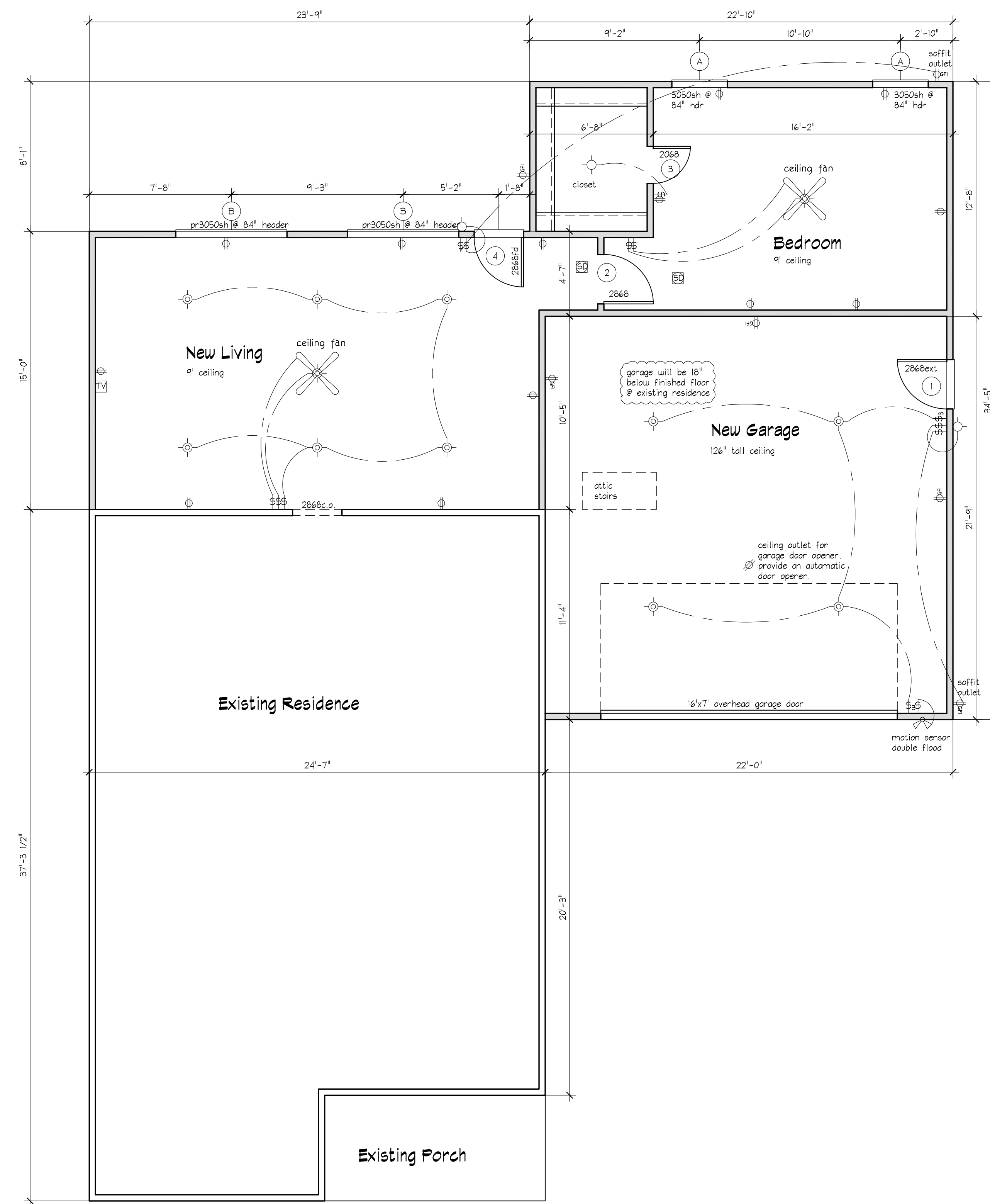

FLOOR + ELECTRICAL PLAN

SCALE 1/4" = 1'-0"

Doors Schedule:

ID#	Size	Description	Quantity
1	2868	Exterior as Selected	1
2	2868	Interior as Selected	1
3	2068	Interior as Selected	1
4	2868	Exterior 1-Lite Glass Door	1

Windows Schedule:

ID#	Size	Description	Quantity
A	3050	Single Hung	2
B	Pair 3050	Single Hung	3

All windows in wet areas, in stairwell, and/or closer than 24" to a door to have tempered glass.

Areas:

Existing HVAC Area	850 sq. ft.
New HVAC Area	651 sq. ft.
Total HVAC Area	1,501 sq. ft.
Garage	491 sq. ft.
Existing Porch	68 sq. ft.
New Slab	1,142 sq. ft.
New Total Under Roof	2,060 sq. ft.

REVISIONS:

11/02/2023

J. Karlovich
Home Design

(214) 674-0290 : Phone
jkarlovichhomedesign.com

These plans are intended to provide the basic construction information necessary to substantially complete the structure. Like most home designs, this firm, J. Karlovich Home Design, is not being an architectural or engineering firm stands no liability for structural or architectural design integrity. Every effort has been made to ensure all dimensions are correct and governmental regulations have been met. If any error or omission does occur it is the sole responsibility of the contractor and/or the owner to correct the error and/or omission at his own expense and not the responsibility of J. Karlovich Home Design. These plans are intended to be a one time use for this address ONLY.

Willow Creek Custom Homes
469-338-0141

A Custom Addition for:
Jake Rashell & Nicole Smith
603 E Rusk Street
Abstract No. 14
B.F. Boydston Survey
City of Rockwall, Rockwall County, Texas





NOV 11 2004

These plans are intended to provide the basic construction information necessary to substantially complete this structure. Like most home designs, this firm, J. Karlovich Home Design, is not being an architectural or engineering firm stands no liability for structural or architectural design integrity. Every effort has been made to ensure all dimensions are correct and governmental regulations have been met. If any error or omission does occur it is the sole responsibility of the contractor and/or the owner to correct the error and/or omission at his own expense and not the responsibility of J. Karlovich Home Design. These plans are intended to be a one-time use for this address ONLY.

Willow Creek Custom Homes
469-338-0141

A Custom Addition for:
Jake Rashell & Nicole Smith

603 E Rusk Street
Abstract No. 14
B.F. Boydston Survey
City of Rockwall, Rockwall County, Texas

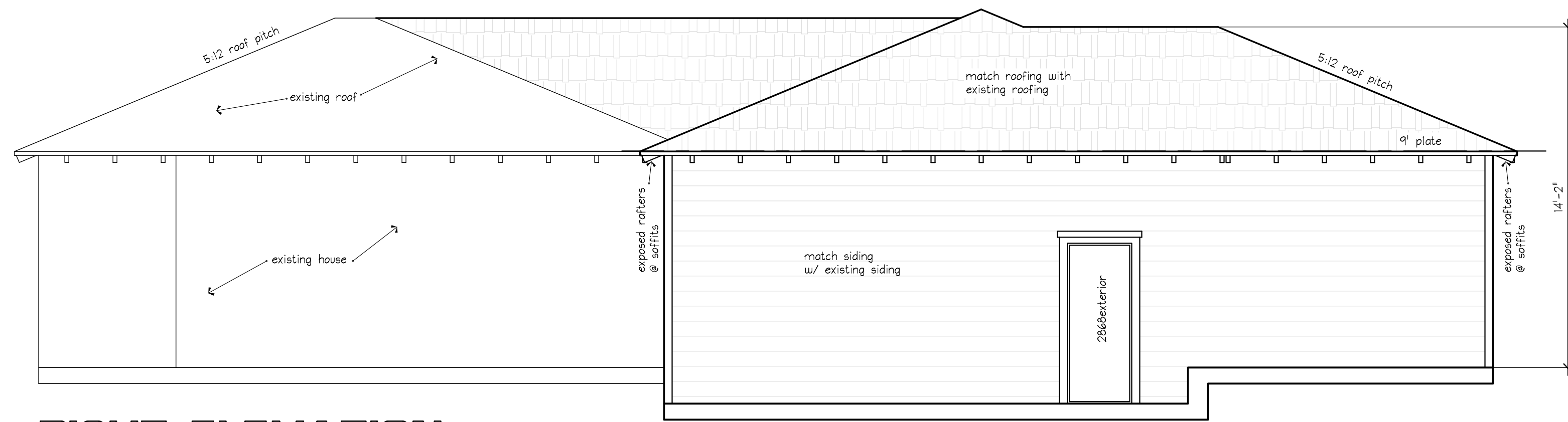

RIGHT ELEVATION

SCALE 1/4" = 1'-0"

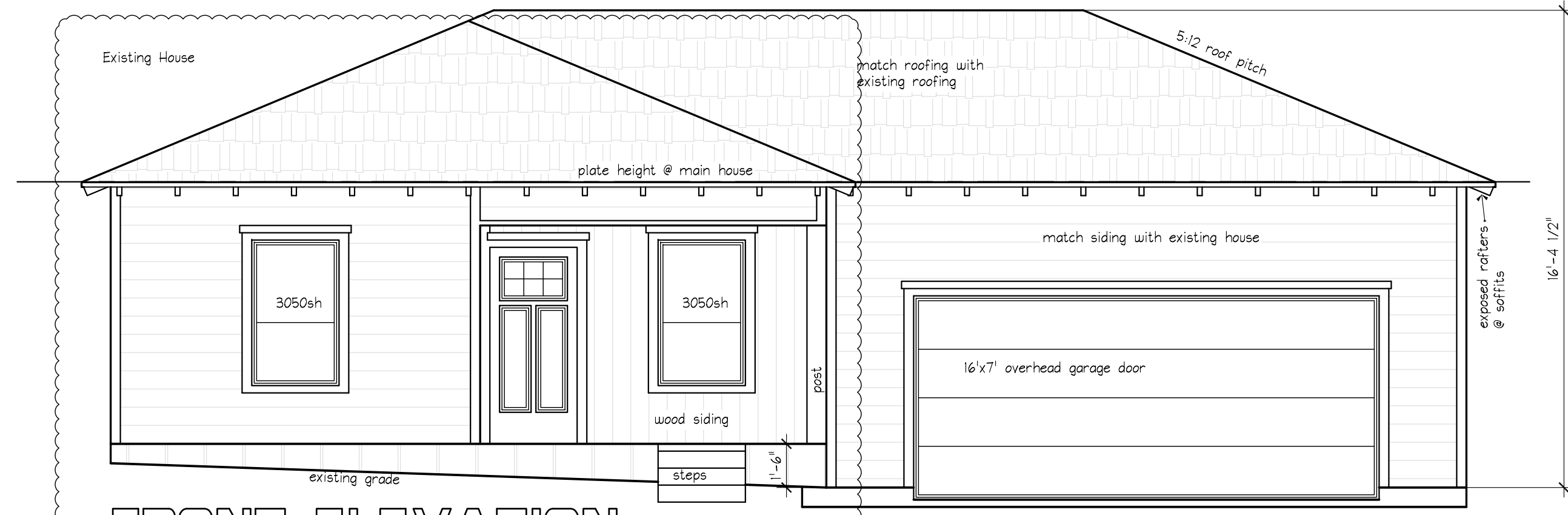

FRONT ELEVATION

SCALE 1/4" = 1'-0"

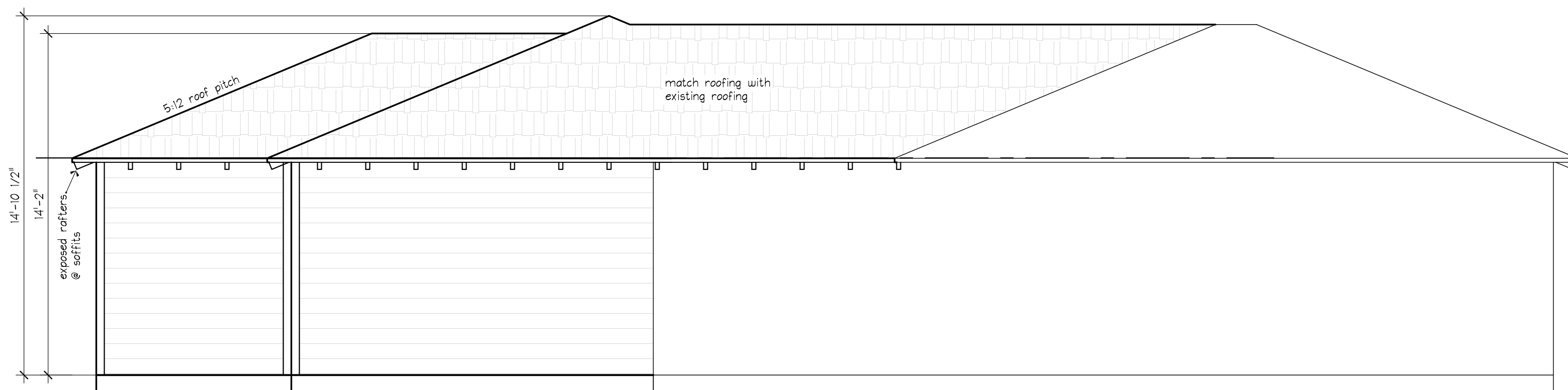

LEFT ELEVATION

SCALE 1/4" = 1'-0"

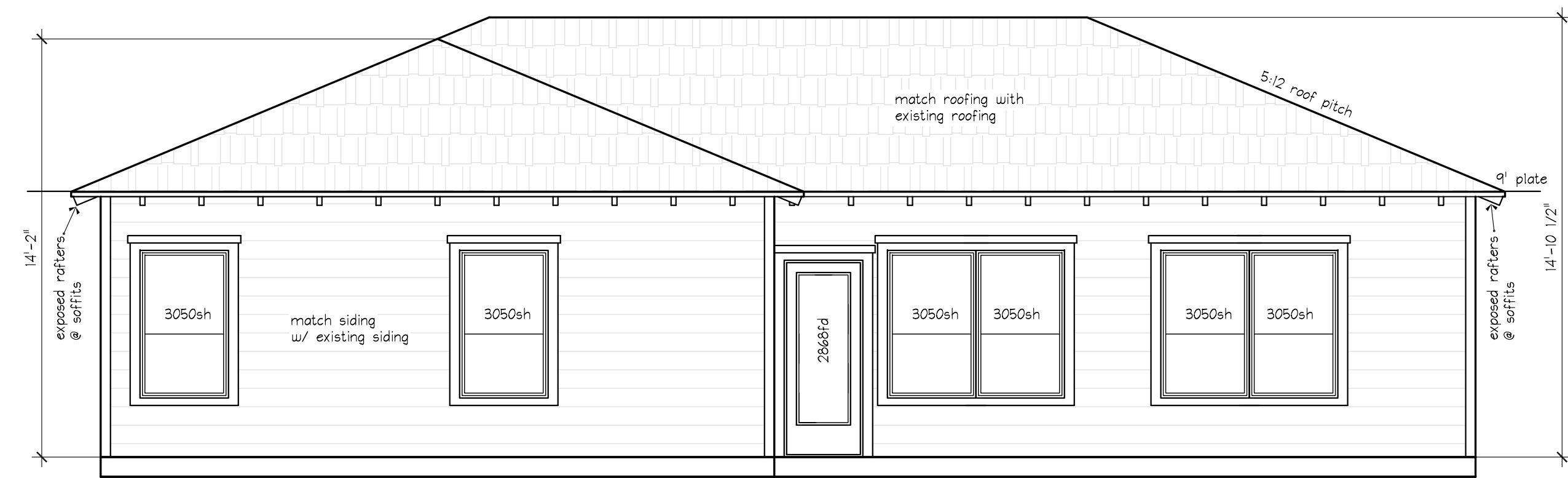

REAR ELEVATION

SCALE 1/4" = 1'-0"



CITY OF ROCKWALL

HISTORIC PRESERVATION ADVISORY BOARD CASE MEMO

PLANNING AND ZONING DEPARTMENT

385 S. GOLIAD STREET • ROCKWALL, TX 75087

PHONE: (972) 771-7745 • EMAIL: PLANNING@ROCKWALL.COM

TO: Historic Preservation Advisory Board
DATE: November 16, 2023
APPLICANT: Michael Cheatham
CASE NUMBER: H2023-020; *Small Matching Grant for 603 E. Rusk Street*

On October 27, 2023, staff received applications for a Certificate of Appropriateness (COA) [Case No. H2023-019], a *Small Matching Grant* [Case No. H2023-020], and a *Building Permit Fee Waiver* [Case No. H2023-021] from the contractor -- Michael Cheatham -- on behalf of the property owners (Jake Rashell and Nicole Smith) for the purpose of constructing an addition to the existing single-family home on the subject property. The subject property is located at 603 E. Rusk Street and is designated as a *Low-Contributing Property*. According to Section 08, *Small Matching Grants*, of Article 11, *Development Applications and Review Procedures*, of the Unified Development Code (UDC), residential properties located within the Old Town Rockwall (OTR) Historic District or the Southside Residential Neighborhood Overlay (SRO) District that are *Contributing* (i.e. *High, Medium, or Low Contributing*) shall be eligible for a total grant amount up to \$1,000.00. In this case, the subject property is located within the Old Town Rockwall (OTR) District and is classified as a *Low-Contributing Property*. The project includes improvements that will be visible from the street (i.e. *adding a 400 SF, two [2] car garage the right side of the home that will match the primary structure*) and, based on the applicant's scope of work, the property is eligible for matching funds. The total valuation of the project provided by the applicant is \$120,000.00, which makes the project eligible for a *Small Matching Grant* of up to \$1,000.00; however, approval of this request is discretionary decision for the Historic Preservation Advisory Board (HPAB). As of October 1, 2023, the Historic Preservation Advisory Board (HPAB) has approved two (2) *Small Matching Grants* for FY2024. Should this request be approved, the *Small Matching Grants Fund* would be reduced to \$2,500.00.



HISTORIC PRESERVATION ADVISORY BOARD APPLICATION

City of Rockwall
Planning and Zoning Department
385 S. Goliad Street
Rockwall, Texas 75087

STAFF USE ONLY

CASE NUMBER: _____

NOTE: THE APPLICATION IS NOT CONSIDERED ACCEPTED BY THE CITY UNTIL THE PLANNING DIRECTOR HAS SIGNED BELOW.

DIRECTOR OF PLANNING: _____

DATE RECEIVED: _____

RECEIVED BY: _____

APPLICATION:

- CERTIFICATE OF APPROPRIATENESS (COA)
- LOCAL LANDMARK EVALUATION & DESIGNATION
- BUILDING PERMIT WAIVER & REDUCTION PROGRAM
- SMALL MATCHING GRANT APPLICATION

SPECIAL DISTRICTS [SELECT APPLICABLE]:

- OLD TOWN ROCKWALL HISTORIC (OTR) DISTRICT
- PLANNED DEVELOPMENT DISTRICT 50 (PD-50)
- SOUTHSIDE RESIDENTIAL NEIGHBORHOOD OVERLAY (SRO) DISTRICT
- DOWNTOWN (DT) DISTRICT

CONTRIBUTING STATUS [SELECT APPLICABLE]:

- LANDMARKED PROPERTY
- HIGH CONTRIBUTING PROPERTY
- MEDIUM CONTRIBUTING PROPERTY
- LOW CONTRIBUTING PROPERTY
- NON-CONTRIBUTING PROPERTY

CURRENT LAND USE OF THE SUBJECT PROPERTY:

- RESIDENTIAL
- COMMERCIAL

PROPERTY INFORMATION [PLEASE PRINT]

ADDRESS 603 EAST RUSK ST ROCKWALL TX 75087

SUBDIVISION _____ LOT _____ BLOCK _____

OWNER/APPLICANT/AGENT INFORMATION [PLEASE PRINT/CHECK THE PRIMARY CONTACT/ORIGINAL SIGNATURES ARE REQUIRED]

IS THE OWNER OF THE PROPERTY THE PRIMARY CONTACT? YES NO

APPLICANT(S) IS/ARE: OWNER TENANT NON-PROFIT RESIDENT

CHECK THIS BOX IF OWNER AND APPLICANT ARE THE SAME.

OTHER, SPECIFY: _____

OWNER(S) NAME JAKE RASHELL / NICOLE SMITH

APPLICANT(S) NAME MICHAEL CHEATHAM

ADDRESS 603 EAST RUSK ST ROCKWALL

ADDRESS 1821 TRAIL DR ROCKWALL TX
75087

PHONE 972-750-8802 / 208-791-9225

PHONE 469-734-6055

E-MAIL JAVERASHELL@GMAIL.COM
SMITHNCL01@GMAIL.COM

E-MAIL OFFICE@WILLOWCREEKCUSTOMHOMES.COM

SCOPE OF WORK/REASON FOR EVALUATION REQUEST [PLEASE PRINT]

CONSTRUCTION TYPE [CHECK ONE]:

- EXTERIOR ALTERATION
- NEW CONSTRUCTION
- ADDITION
- DEMOLITION
- RELOCATIONS
- OTHER, SPECIFY: _____

ESTIMATED COST OF CONSTRUCTION/DEMOLITION OF THE PROJECT (IF APPLICABLE): \$ 120,000

PROJECT DESCRIPTION. IN THE SPACE PROVIDED BELOW OR ON A SEPARATE SHEET OF PAPER, DESCRIBE IN DETAIL THE WORK THAT WILL BE PERFORMED ON SITE. FOR LOCAL LANDMARK EVALUATION & DESIGNATION REQUESTS INDICATE ANY ADDITIONAL INFORMATION YOU MAY HAVE CONCERNING THE PROPERTY, HISTORY, SIGNIFICANCE, PRESENT CONDITIONS, STATUS, CURRENT OR PAST USE(S), ETC. STAFF RECOMMENDS THAT PHOTOGRAPHS OF THE INTERIOR AND EXTERIOR OF THE PROPERTY ARE SUBMITTED WITH THIS APPLICATION.

ADDING ROUGHLY 615 SF OF AIR CONDITIONED SPACE TO BACK OF HOME. 375 SF TO BE LIVING ROOM & 240 SF TO BE BEDROOM & CLOSET. ADDING A 400 SF 2 CAR GARAGE TO RIGHT SIDE OF HOME. ALL NEW EXTERIOR FACADE TO MATCH EXISTING EXCEPT POSSIBLY USING A HARDY SIDING ON BACK NOT EXPOSED TO STREET IF ALLOWED.

OWNER & APPLICANT STATEMENT [ORIGINAL SIGNATURES REQUIRED]

I ACKNOWLEDGE THAT I HAVE READ THIS APPLICATION AND THAT ALL INFORMATION CONTAINED HEREIN IS TRUE AND CORRECT TO THE BEST OF MY KNOWLEDGE. FURTHERMORE, I UNDERSTAND THAT IT IS NECESSARY FOR ME OR A REPRESENTATIVE TO BE PRESENT AT A PUBLIC HEARING FOR THIS CASE TO BE APPROVED.

OWNER'S SIGNATURE _____

APPLICANT'S SIGNATURE [Signature]



H2023-020: Small Matching Grant for 603 E Rusk



Case Location Map = 



City of Rockwall

Planning & Zoning Department
385 S. Goliad Street
Rockwall, Texas 75087
(P): (972) 771-7745
(W): www.rockwall.com

The City of Rockwall GIS maps are continually under development and therefore subject to change without notice. While we endeavor to provide timely and accurate information, we make no guarantees. The City of Rockwall makes no warranty, express or implied, including warranties of merchantability and fitness for a particular purpose. Use of the information is the sole responsibility of the user.





City of Rockwall

Planning & Zoning Department
385 S. Goliad Street
Rockwall, Texas 75087
(P): (972) 771-7745
(W): www.rockwall.com

The City of Rockwall GIS maps are continually under development and therefore subject to change without notice. While we endeavor to provide timely and accurate information, we make no guarantees. The City of Rockwall makes no warranty, express or implied, including warranties of merchantability and fitness for a particular purpose. Use of the information is the sole responsibility of the user.

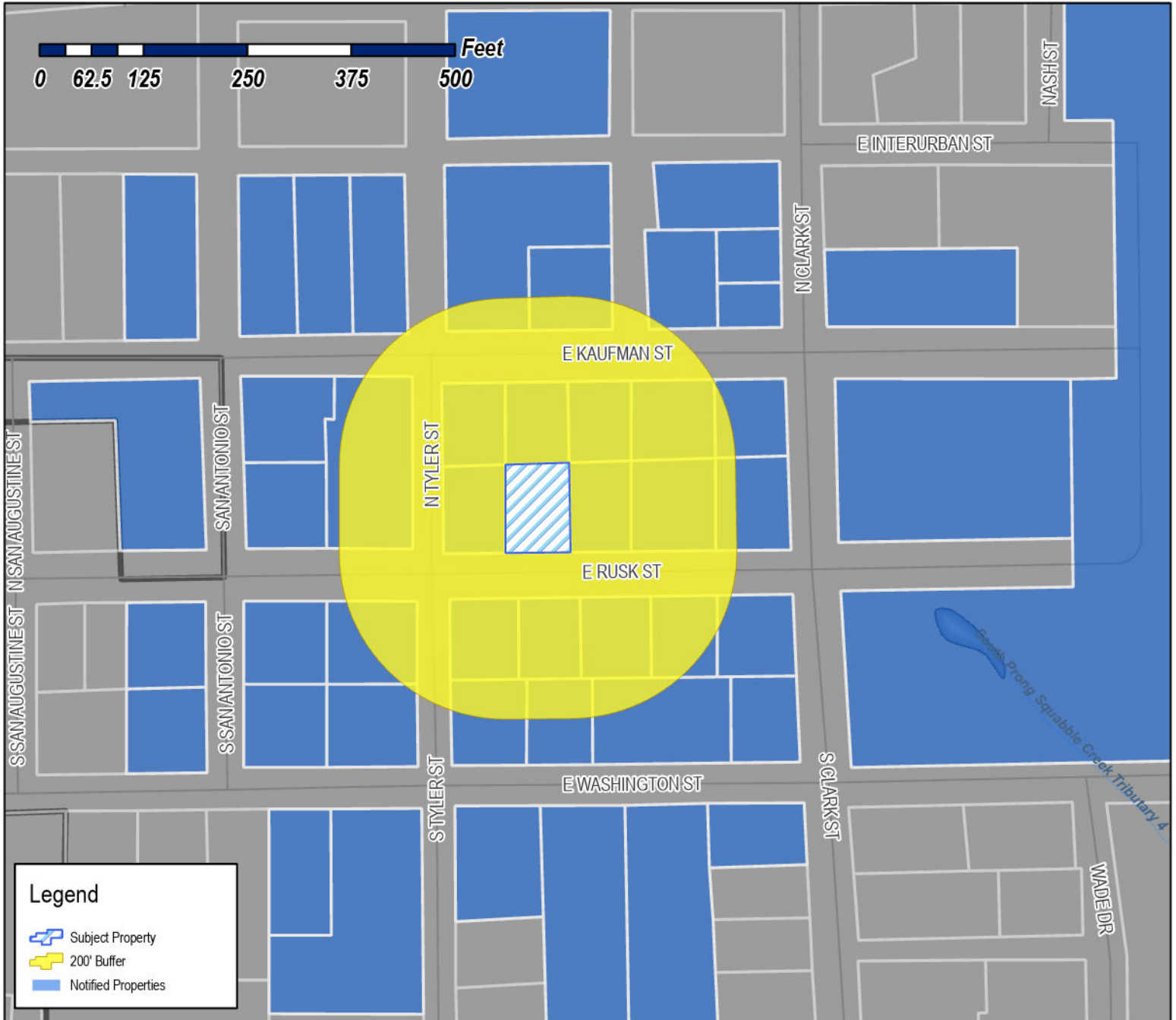

Case Number: H2023-020
Case Name: Small Matching Grant for
 603 E Rusk Street
Case Type: Historic
Zoning: Single-Family 7 (SF-7) District
Case Address: 603 E Rusk Street

Date Saved: 10/30/2023

For Questions on this Case Call: (972) 771-7746

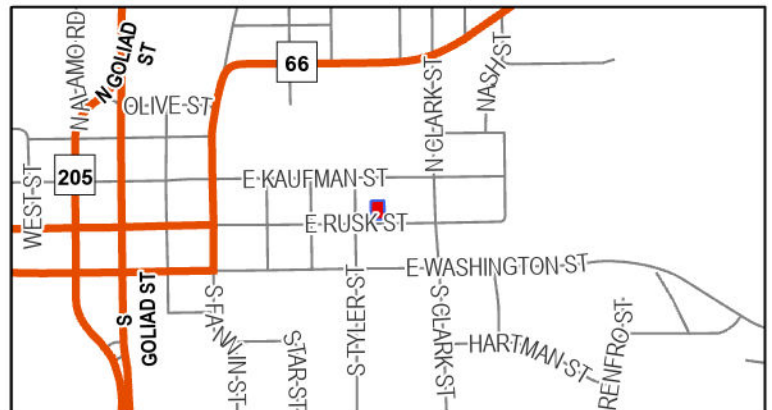

SMILEY KAREN APRIL
605 E RUSK ST
ROCKWALL, TX 75087

INDEPENDENT ADMINISTRATOR - ESTATE OF
ROBERT THOMAS WIKTORCH
P.O. BOX 3061
WARMINSTER, PA 18974

DUTT JOHN RICHARD JR ETUX
505 E WASHINGTON ST
ROCKWALL, TX 75087

BIRKENBACK JOSSEPH M & OLGA M
506 E RUSK ST
ROCKWALL, TX 75087

CLARK JENNIFER A
610 E KAUFMAN ST
ROCKWALL, TX 75087

GALVAN CARMAN
604 E KAUFMAN ST
ROCKWALL, TX 75087

OCCUPANT
603 E RUSK ST
ROCKWALL, TX 75087

INTEGRITY ALL CASH HOME BUYERS LLC
7340 BAKER BLVD #392
RICHLAND HILLS, TX 76118

ROCKWALL COMMUNITY PLAYHOUSE
609 E RUSK ST
ROCKWALL, TX 75087

OCCUPANT
601 E WASHINGTON ST
ROCKWALL, TX 75087

GLASS JERRY
301 MEADOWDALE DR
ROCKWALL, TX 75087

GREEN JAMES KEITH II & HOLLY NICOLE
605 E WASHINGTON ST
ROCKWALL, TX 75087

ROCKWALL COMMUNITY PLAYHOUSE
609 E RUSK ST
ROCKWALL, TX 75087

REEVES ASHLEY ELLEN & DANIEL GARRET
609 E WASHINGTON ST
ROCKWALL, TX 75087

WEBB RODNEY D AND FRAN W
507 E RUSK ST
ROCKWALL, TX 75087

HARPER VICKI DAWSON
605 E KAUFMAN ST
ROCKWALL, TX 75087

OCCUPANT
601 E KAUFMAN ST
ROCKWALL, TX 75087

HARPER LYDIA
1200 CLEVELAND STREET APT 327
DENTON, TX 76201

HARPER VICKI DAWSON
605 E KAUFMAN ST
ROCKWALL, TX 75087

ROCKWALL COMMUNITY PLAYHOUSE
609 E RUSK ST
ROCKWALL, TX 75087

COUNTY OF ROCKWALL
101 E Rusk ST
ROCKWALL, TX 75087

WILLIAMS JERRY LANE
608 E RUSK ST
ROCKWALL, TX 75087

SMITH GREGORY P & MARILYN
610 E RUSK ST
ROCKWALL, TX 75087

ROBINSON NELDA
602 E RUSK ST
ROCKWALL, TX 75087

HORNER ANDREA J
604 E RUSK ST
ROCKWALL, TX 75087

OCCUPANT
102 S CLARK ST
ROCKWALL, TX 75087

KINSEY DONALD H & TARI L
2 MANOR COURT
HEATH, TX 75032

OCCUPANT
601 E RUSK ST
ROCKWALL, TX 75087

QUINTON BILLY & AUTUMN
102 N TYLER ST
ROCKWALL, TX 75087

QUINTON BILLY & AUTUMN
102 N TYLER ST
ROCKWALL, TX 75087

OCCUPANT
505 E KAUFMAN ST
ROCKWALL, TX 75087

BALL JUSTIN
2155 CLUBVIEW DR
ROCKWALL, TX 75087

PUBLIC NOTICE



CITY OF ROCKWALL
PLANNING AND ZONING DEPARTMENT
PHONE: (972) 771-7745
EMAIL: PLANNING@ROCKWALL.COM

Property Owner and/or Resident of the City of Rockwall:

You are hereby notified that the Historic Preservation Advisory Board will consider the following application:

Case No. H2023-020: Small Matching Grant for 603 E. Rusk Street

Hold a public hearing to discuss and consider a request by Michael Cheatham on behalf of Jake Rashell and Nicole Smith for the approval of a Small Matching Grant for an addition to an existing single-family home being a Low Contributing Property on a 0.25-acre parcel of land identified as Block 120E of the B. F. Boydston Addition, City of Rockwall, Rockwall County, Texas, zoned Single-Family 7 (SF-7) District, situated within the Old Town Rockwall (OTR) Historic District, addressed as 603 E. Rusk Street, take any action necessary.

For the purpose of considering the effects of such a request, the Historic Preservation Advisory Board will hold a public hearing on Thursday, November 16, 2023 at 6:00 PM. This hearing will be held in the City Council Chambers at City Hall, 385 S. Goliad Street.

As an interested property owner, you are invited to attend these meetings. If you prefer to express your thoughts in writing please return the form to:

Angelica Guevara
Rockwall Planning and Zoning Dept.
385 S. Goliad Street
Rockwall, TX 75087

You may also email your comments to the Planning Department at planning@rockwall.com. If you choose to email the Planning Department please include your name and address for identification purposes.

Your comments must be received by Thursday, November 16, 2023 at 4:00 PM to ensure they are included in the information provided to the Historic Preservation Advisory Board.

Sincerely,

Ryan Miller, AICP
Director of Planning & Zoning

----- PLEASE RETURN THE BELOW FORM -----

Case No. H2023-020: Small Matching Grant for 603 E. Rusk Street

Please place a check mark on the appropriate line below:

I am in favor of the request for the reasons listed below.

I am opposed to the request for the reasons listed below.

Four horizontal grey bars for providing reasons for the response.

Name:

Address:

Tex. Loc. Gov. Code, Sec. 211.006 (d) If a proposed change to a regulation or boundary is protested in accordance with this subsection, the proposed change must receive, in order to take effect, the affirmative vote of at least three-fourths of all members of the governing body. The protest must be written and signed by the owners of at least 20 percent of either: (1) the area of the lots or land covered by the proposed change; or (2) the area of the lots or land immediately adjoining the area covered by the proposed change and extending 200 feet from that area.

PLEASE SEE LOCATION MAP OF SUBJECT PROPERTY ON THE BACK OF THIS NOTICE



TRACT 2
BILLY QUINTON AND
AUTUMN QUINTON
INST. NO.
20160000012152

CARMEN GALVAN
VOL. 1907, PG. 137

(CM)
N.E. CORNER OF
CARMEN GALVAN
VOL. 1907, PG. 137

VICTORY WORSHIP
CENTER, INC.
VOL. 1395, PG. 142

1/2" IRF FOR REFERENCE
S 01°31'27" E - 0.38'

N 89°44'24" E 75.00'

100.00'

N 01°31'27" W

100.00'

TRACT 1
BILLY QUINTON AND
AUTUMN QUINTON
INST. NO.
20160000012152

7,498 sq. ft.
0.17 of an acre

ONE STORY
FRAME NO
FOUNDATION

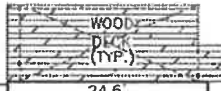

ONE STORY
FRAME
(603)

ROBERT THOMAS
WIKTORCHIK
INST. NO.
2007-00381305

(CM)
S.W. CORNER OF
TRACT 1
BILLY QUINTON AND
AUTUMN QUINTON
INST. NO.
20160000012152

75.00'

S 89°44'24" W 75.00'

PLACE OF
BEGINNING

OHPL OHPL OHPL OHPL OHPL

ASPHALT

E. RUSK STREET



TRACT 2
BILLY QUINTON AND
AUTUMN QUINTON
INST. NO.
20160000012152

CARMEN GALVAN
VOL. 1907, PG. 137

VICTORY WORSHIP
CENTER, INC.
VOL. 1395, PG. 142

1/2" IRF FOR REFERENCE
S 01°31'27" E - 0.38'

(CM)
N.E. CORNER OF
CARMEN GALVAN
VOL. 1907, PG. 137

TRACT 1
BILLY QUINTON AND
AUTUMN QUINTON
INST. NO.
20160000012152

ROBERT THOMAS
WIKTORCHIK
INST. NO.
2007-00381305

(CM)
S.W. CORNER OF
TRACT 1
BILLY QUINTON AND
AUTUMN QUINTON
INST. NO.
20160000012152

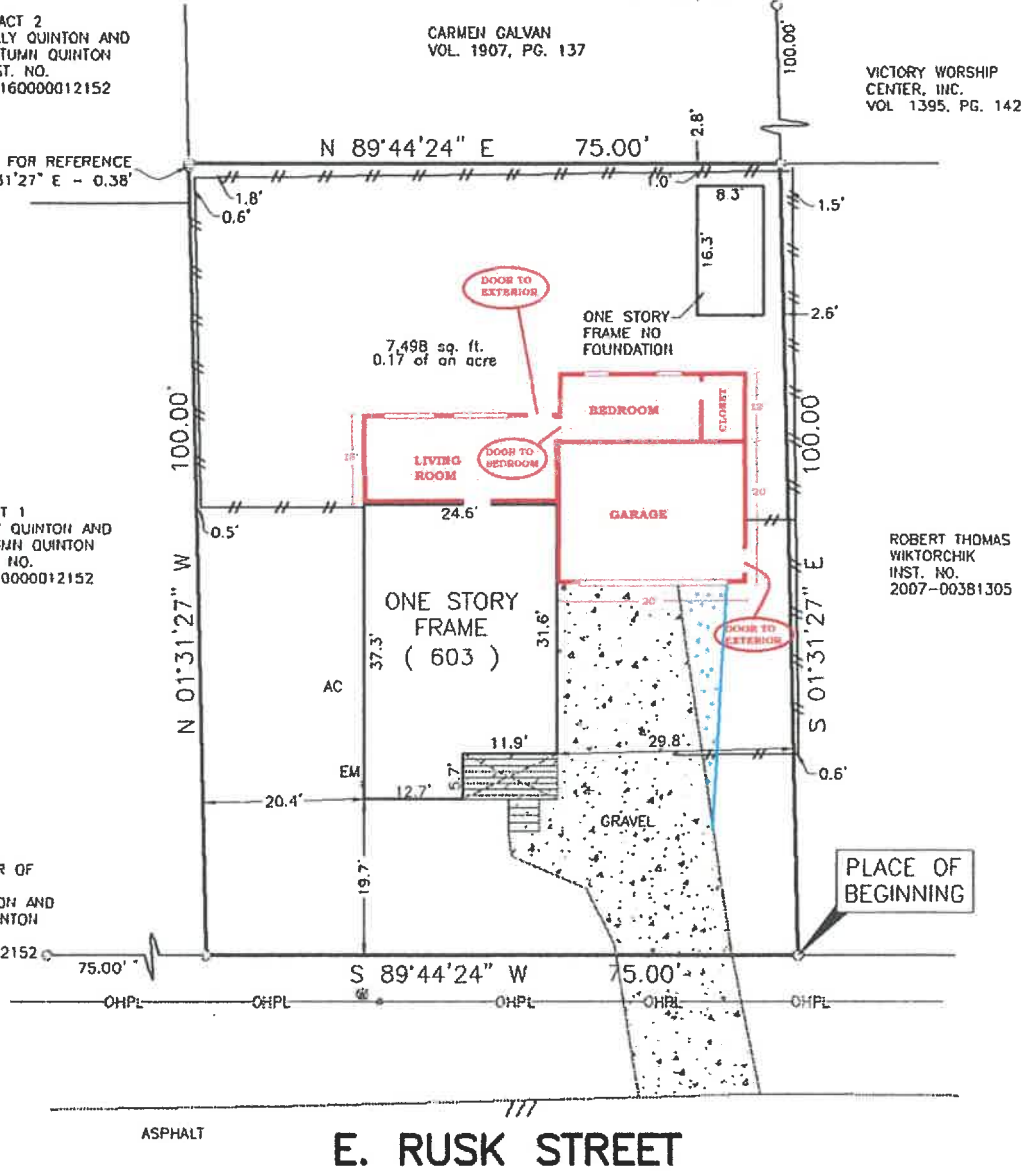



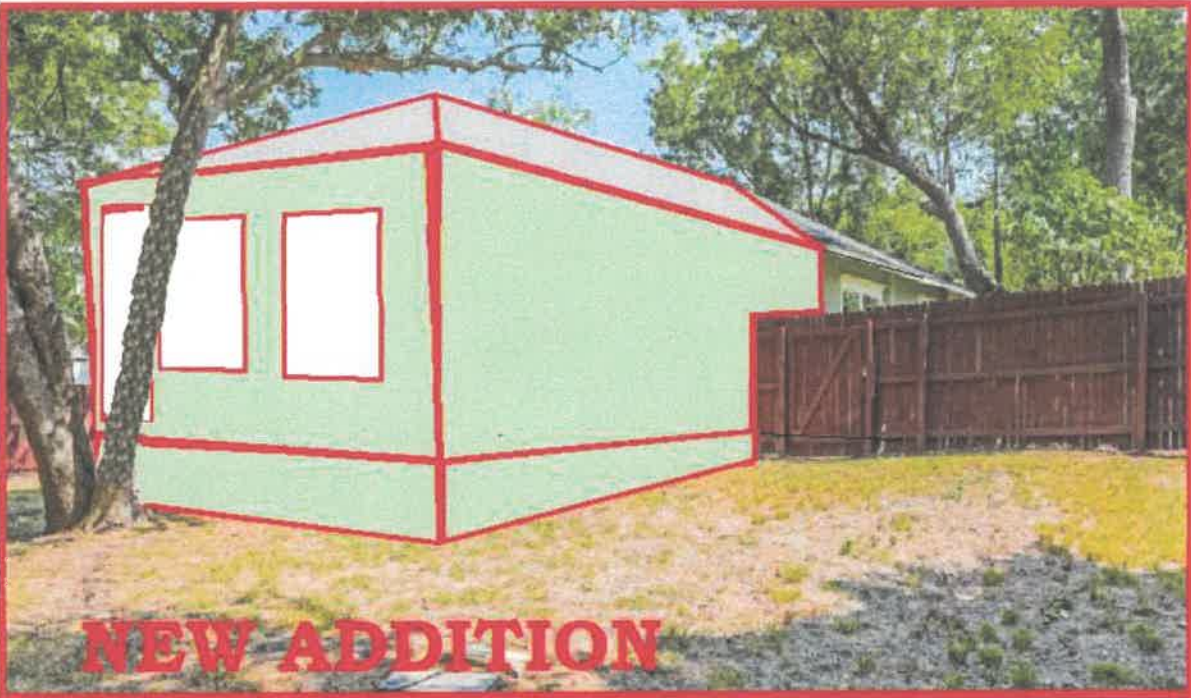

NEW ADDITION



EXISTING

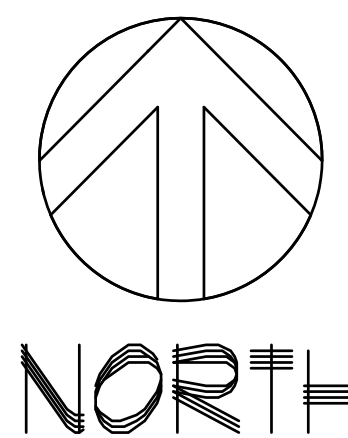
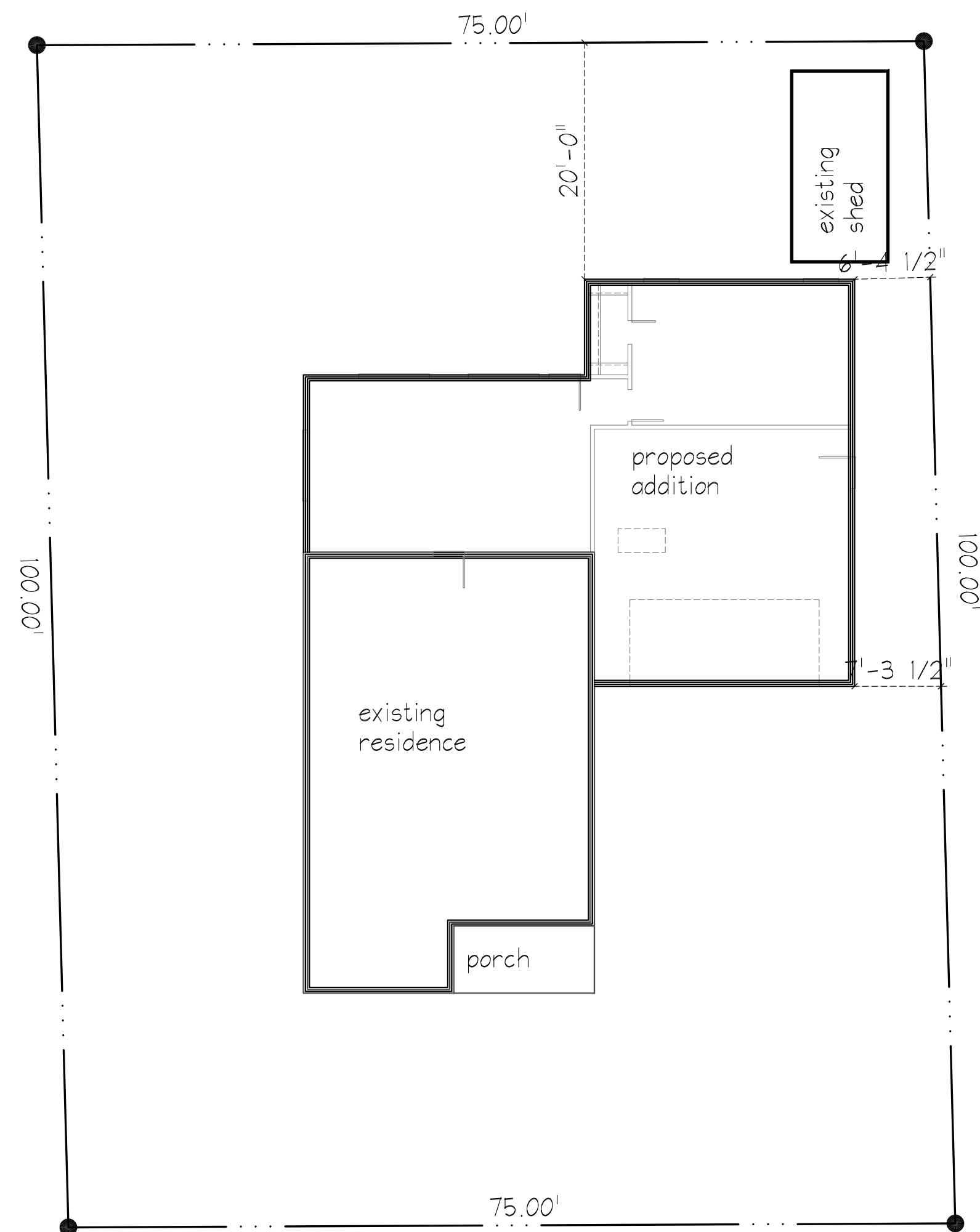

Areas:

Area of Lot	7,498 sq. ft.
Covered Area	1,142 sq. ft.
Percent Covered	15.2%

PLOT PLAN

SCALE 1" = 10'-0"

Notes:

- Do not scale drawings, follow dimensions only. All structural information shown for reference purposes only. Contractor shall have licensed structural engineer review and design all structural elements such as all framing walls, beams, connections, headers, joists and rafters.
- All dimensions are from face of stud to face of stud unless otherwise noted.
- Window sizes indicated on plans are noted by approximate rough openings size. Verify window sizes and "owner furnish windows" with owner prior to construction. Refer to plans and exterior elevations for window types.
- All framing shall be done in accordance with IBC latest edition.
- Spread studs at tub ends to accommodate plumbing and provide blocking, top and bottom, at shower to secure plumbing.
- Exterior sheathing shall be 5/8" OSB.
- All interior walls shall be covered with 1/2" gypsum board with metal corner reinforcing. Drywall finish should include taping over joints, applying joint compound and sanding the compound for a smooth finish. Verify with owner the level of drywall texturing.
- All walls and ceilings in garage and garage storage areas to have 5/8" Type-X gypsum board with 1-hour fire rating. All exterior doors in garage and attic access to be metal or solid core with a 20 minute fire rating.
- Provide 1/2" "moisture resistant" gypsum board at all wet locations.
- All finishes to be chosen and verified by owner.
- Contractor shall field verify all cabinet dimensions before fabrication.
- All millwork to be chosen and verified by owner. Contractor shall submit "shop drawings" at owners request.
- Provide 1/2" cement board for tile backer.
- Provide min. 4 - gang 2x4 studs at glue-lam bearing.
- All work shall be in accordance with National Plumbing Code, Latest Edition.
- Contractor shall provide HVAC "duct layout" for approval prior to fabrication. For coordination with fixtures and diffuser location.
- Verify all column type, size, and material with owner prior to construction.
- Prefabricated fireplace construction shall meet or exceed all applicable codes regarding use of fire separations, clearances, etc. It is the contractor's responsibility to ensure that all items and construction meet or exceed code. Overall flue height shall be coordinated to match height shown on plans and shall not exceed the top of chimney chase as constructed. All fireplace chase walls shall be insulated inside and outside. Provide horizontal "draft stops" at each floor level by packing 6" (R19) insulation between 2x4 joists.
- Provide combustion air vents with screen and back damper for fireplaces, wood stoves and any appliance with an open flame.
- All bath and toilet area walls shall have water resistant gypsum boards.
- All plumbing walls shall be 2x6.
- Bedroom windows shall have a minimum net clear opening of 5.7 square feet, a minimum net clear openable width of 20", a minimum net clear openable height of 24", and have a maximum finish sill height of 42" from finished floor. All glass located within 18" of floor, 24" of a door or located within 60" of floor at bath tubs, whirlpools, showers, saunas, steam rooms, or hot tubs shall be tempered.
- Attic HVAC units shall be located within 20' of its service opening. Return air grills shall not be located within 10' of a gas fired appliance.
- All exposed insulation shall have a flame spread rating of less than 25 and a smoke density rating of less than 450.

MASTER REVISION INDEX			APPLICABLE CODES
SHEET #	DESCRIPTION	SCALE	
1	PLOT PLAN	1"=10'-0"	2021 INTERNATIONAL FIRE CODE
2	DEMO PLAN & REMODEL PLAN W/ ELECTRICAL	1/4"=1'-0"	2021 INTERNATIONAL BUILDING CODE
3	FOUNDATION LAYOUT & ROOF PLAN	1/4"=1'-0"	2021 INTERNATIONAL PLUMBING CODE
4	FRONT, REAR, LEFT, & RIGHT ELEVATION	1/4"=1'-0"	2020 NATIONAL ELECTRICAL CODE
5	STANDARD DETAILS	N.T.S.	2021 INTERNATIONAL RESIDENTIAL CODE
			2021 INTERNATIONAL ENERGY CONSERVATION CODE
			2021 INTERNATIONAL FUEL & GAS CODE
			2021 INTERNATIONAL GREEN CONSTRUCTION CODE

REVISIONS:

11/02/2023

J. Karlovich
Home Design

(214) 674-0290 : Phone
jkarlovichhomedesign.com

These plans are intended to provide the basis construction information necessary to substantially complete the structure. Like most home designers, this firm, J. Karlovich Home Design, is not being an architectural or engineering firm stands no liability for structural or architectural design integrity. Every effort has been made to ensure all dimensions are correct and governmental regulations have been met. If any error or omission does occur it is the sole responsibility of the contractor and/or the owner to correct the error and/or omission at his own expense and not the responsibility of J. Karlovich Home Design. These plans are intended to be a one-time use for this address ONLY.

Willow Creek Custom Homes
469-338-0141

A Custom Addition for:
Jake Rashell & Nicole Smith
603 E Rusk Street
Abstract No. 14
B.F. Boydston Survey
City of Rockwall, Rockwall County, Texas

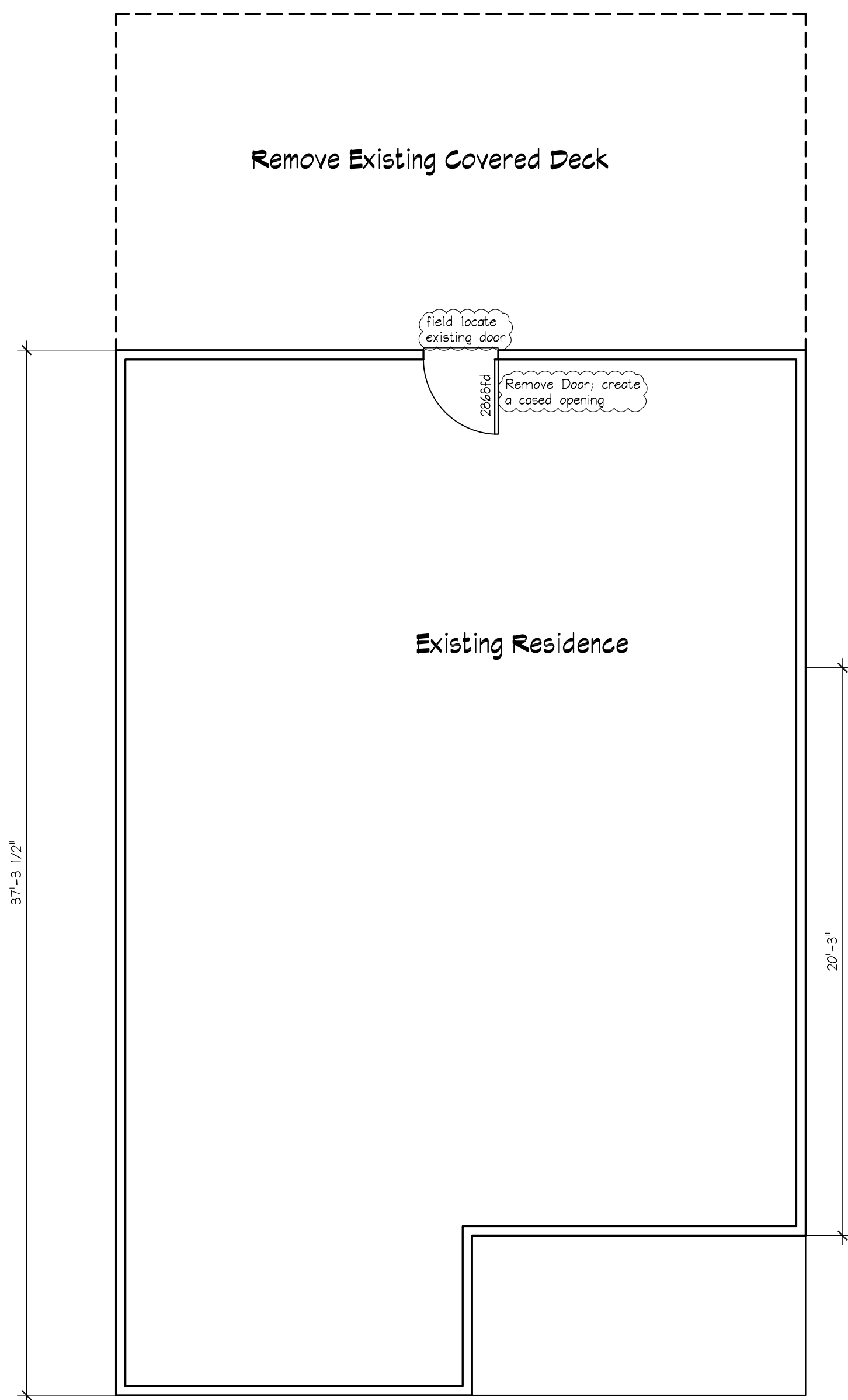

EXISTING + DEMO PLAN
SCALE 1/4" = 1'-0"

ELECTRICAL LEGEND	
⊕	Surface/Ceiling Mount
⊙	Recessed Eyeball Mount
⊕	Ground-up Landscape Flood
⊕	Wall Mounted
⊕	6" LED Recessed Can Light
⊕	6" Vapor Recessed Can Light
⊕	Single Fluorescent Strip
⊕	Double Flood w/ Motion Sensor (exterior)
⊕	LED Fluorescent Lighting
⊕	Exhaust Fan (minimum 90 cfm)
⊕	Ceiling Heater
⊕	Carbon Monoxide Detector
⊕	Sub Panel
⊕	Intercomm System
⊕	Telephone Jack
⊕	Bundled Cable (2 RG6 Coax, 2 CAT6, 2 Fiber)
⊕	Network (CAT6 Only)
⊕	Speaker (1/4" Speaker Wiring)
⊕	Smoke and Carbon Monoxide Detector
⊕	Duplex Outlet (125 volt)
⊕	Appliance Outlet (240 volt)
⊕	GFI Outlet (UL Approved)
⊕	Ceiling Outlet (125 volt)
⊕	Floor Outlet (pre-wire before pouring foundation)
⊕	Single Light Switch
⊕	Three Way Light Switch
⊕	Light Switch with Dimmer Control
⊕	Ceiling Fan (provide proper ceiling brace)
⊕	Electrical Breaker Box (refer to electrician for size)

Notes:

- All electrical work shall be done in accordance with National Electric Code, Latest Edition.
- Provide a J-Box below counter for dishwasher, ice machine, compactor and range.
- Provide waterproof covers on all exterior outlets and ground fault interrupter receptacles in all wet and exterior locations.
- All fixtures shall be UL Approved.
- Provide "bustion" at entry doors and door chimes.
- Verify water heater and HVAC electrical requirements prior to construction.
- Verify all outlet, switch, fixture, television and telephone locations with owner prior to construction.
- Provide light fixtures and outlets in attic as per owners instructions.
- Verify all light fixtures and plug type and location with owner prior to installation.
- Center all light fixtures in each room.

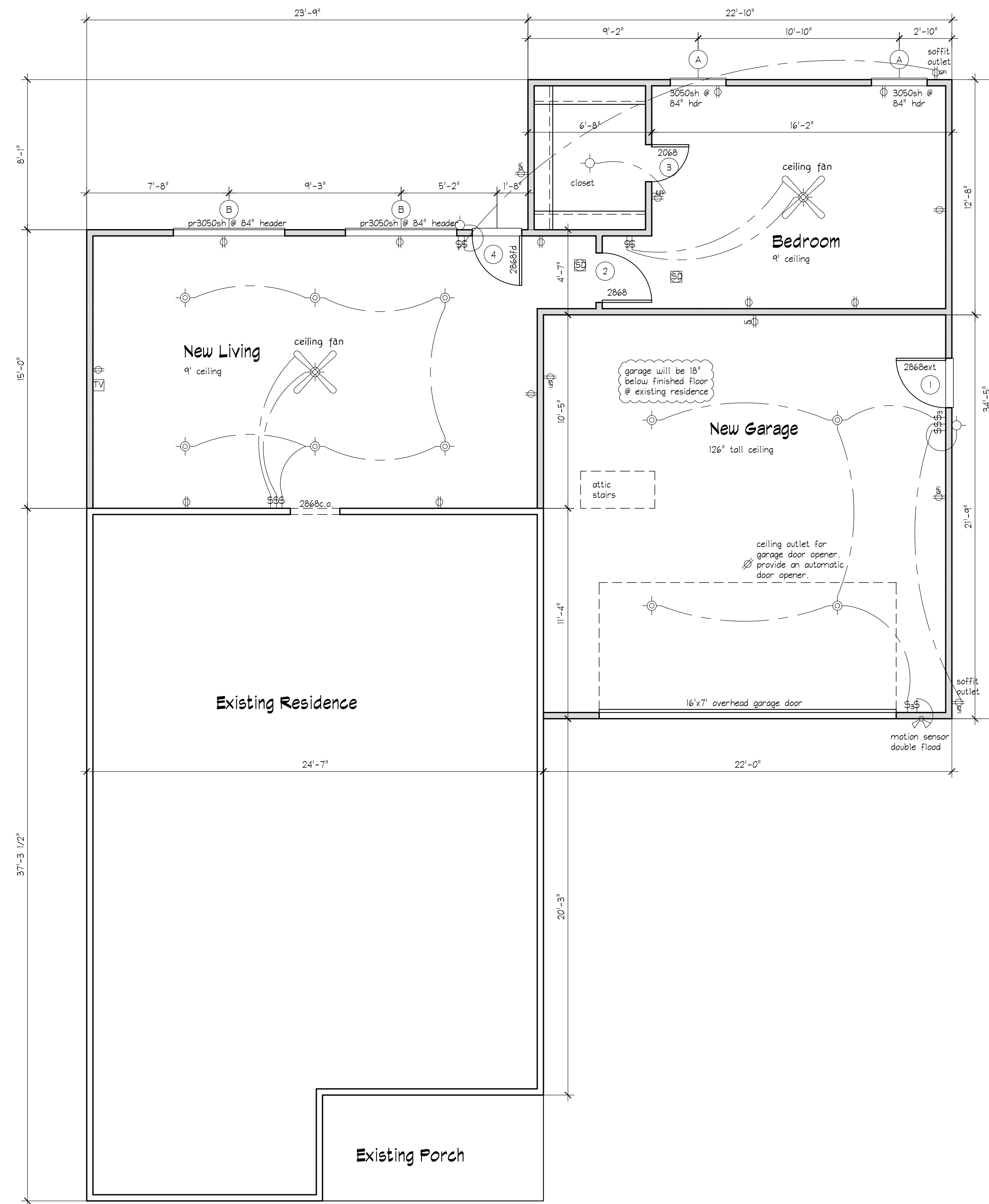

FLOOR + ELECTRICAL PLAN
SCALE 1/4" = 1'-0"

Doors Schedule:

ID#	Size	Description	Quantity
1	2868	Exterior as Selected	1
2	2868	Interior as Selected	1
3	2068	Interior as Selected	1
4	2868	Exterior 1-Lite Glass Door	1

Windows Schedule:

ID#	Size	Description	Quantity
A	3050	Single Hung	2
B	Pair 3050	Single Hung	3

****All windows in wet areas, in stairwell, and/or closer than 24" to a door to have tempered glass.****

Areas:

Existing HVAC Area	850 sq. ft.
New HVAC Area	651 sq. ft.
Total HVAC Area	1,501 sq. ft.
Garage	491 sq. ft.
Existing Porch	68 sq. ft.
New Slab	1,142 sq. ft.
New Total Under Roof	2,060 sq. ft.

REVISIONS:
11/02/2023

J. Karlovich
Home Design

(214) 674-0290 : Phone
jkarlovichhomedesign.com

These plans are intended to provide the basic construction information necessary to substantially complete the structure. Like most home designs, this firm, J. Karlovich Home Design, is not being an architectural or engineering firm stands no liability for structural or architectural design integrity. Every effort has been made to ensure all dimensions are correct and governmental regulations have been met. If any error or omission does occur it is the sole responsibility of the contractor and/or the owner to correct the error and/or omission at his own expense and not the responsibility of J. Karlovich Home Design. These plans are intended to be a one time use for this address ONLY.

Willow Creek Custom Homes
469-338-0141

A Custom Addition for:
Jake Rashell & Nicole Smith
603 E Rusk Street
Abstract No. 14
B.F. Boydston Survey
City of Rockwall, Rockwall County, Texas





NOV 11 2004

These plans are intended to provide the basic construction information necessary to substantially complete this structure. Like most home designers, this firm, J. Karlovich Home Design, is not being an architectural or engineering firm stands no liability for structural or architectural design integrity. Every effort has been made to ensure all dimensions are correct and governmental regulations have been met. If any error or omission does occur it is the sole responsibility of the contractor and/or the owner to correct the error and/or omission at his own expense and not the responsibility of J. Karlovich Home Design. These plans are intended to be a one-time use for this address ONLY.

Willow Creek Custom Homes
469-338-0141

A Custom Addition for:
Jake Rashell & Nicole Smith

603 E Rusk Street
Abstract No. 14
B.F. Boydston Survey
City of Rockwall, Rockwall County, Texas

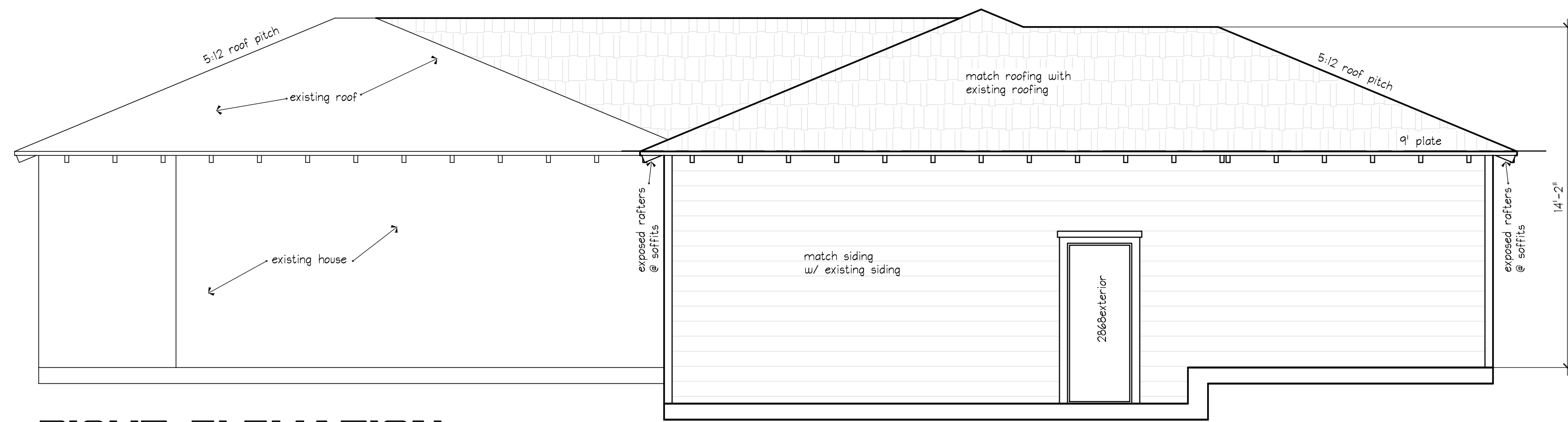

RIGHT ELEVATION

SCALE 1/4" = 1'-0"

Foundations of exterior walls or piers exposed more than ten inches above the adjacent ground level shall be clad in the primary exterior finish material, such as lap siding, and painted to complement the primary exterior finish material.

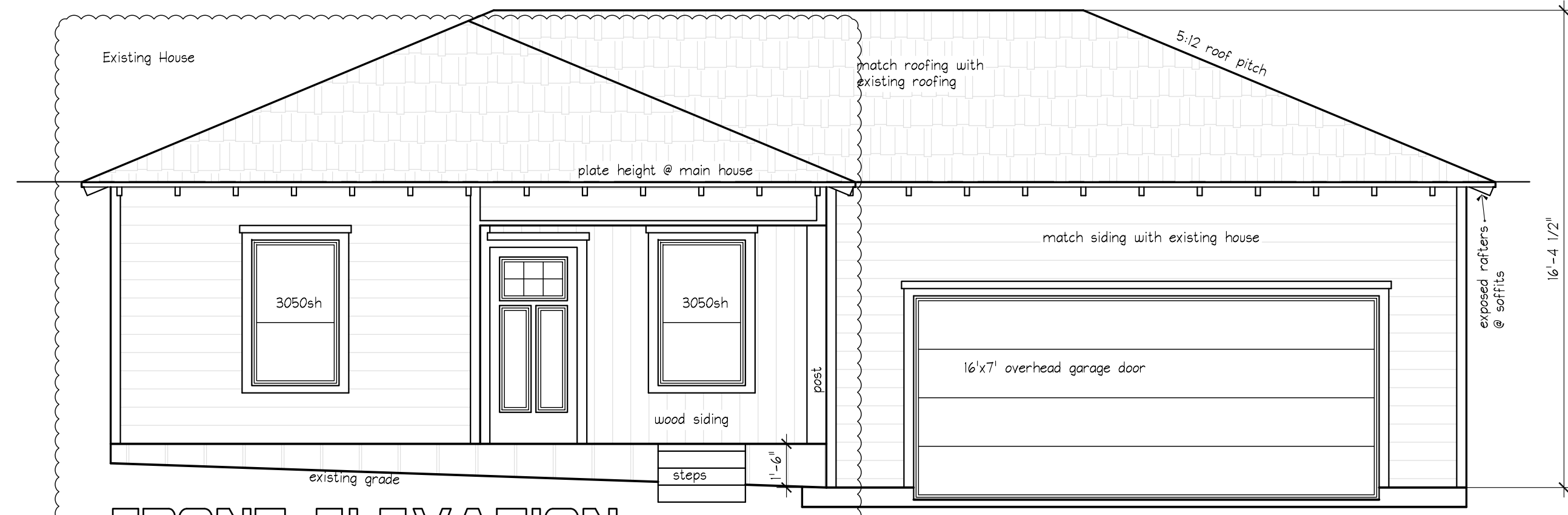

FRONT ELEVATION

SCALE 1/4" = 1'-0"

Foundations of exterior walls or piers exposed more than ten inches above the adjacent ground level shall be clad in the primary exterior finish material, such as lap siding, and painted to complement the primary exterior finish material.

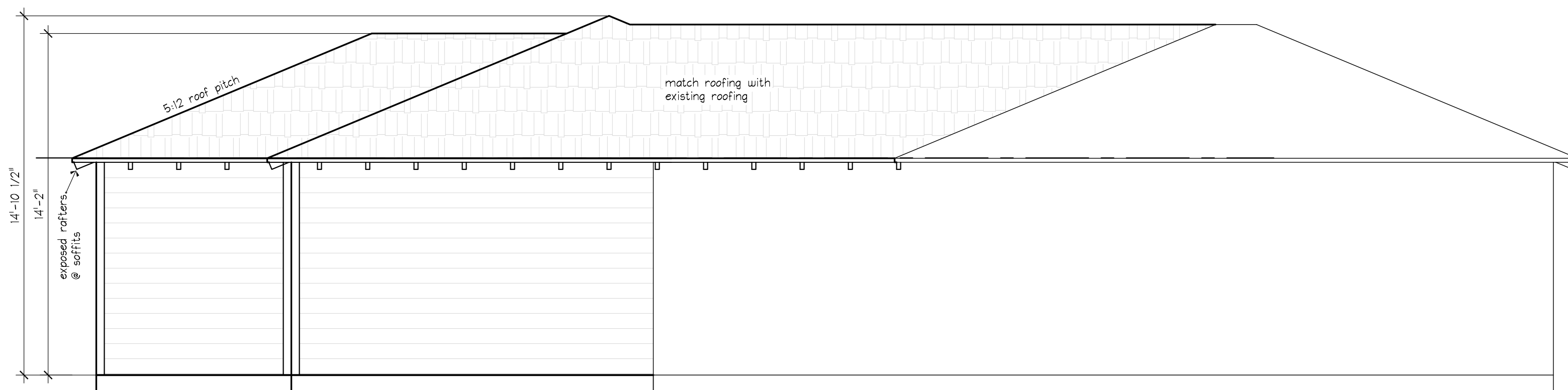

LEFT ELEVATION

SCALE 1/4" = 1'-0"

Foundations of exterior walls or piers exposed more than ten inches above the adjacent ground level shall be clad in the primary exterior finish material, such as lap siding, and painted to complement the primary exterior finish material.

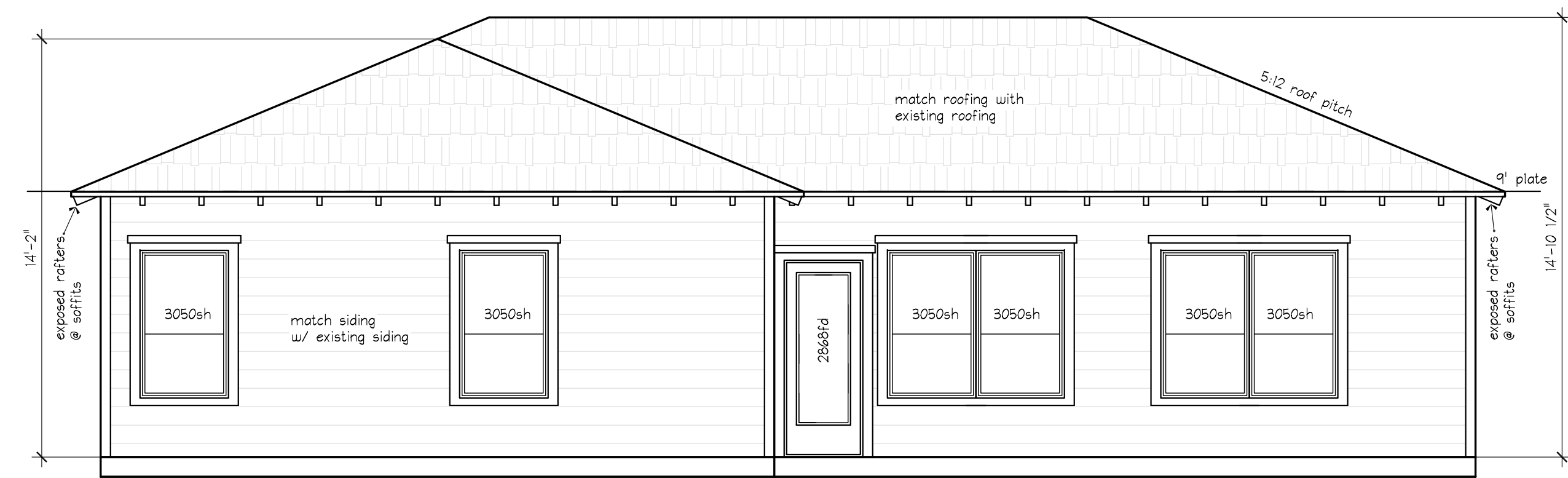

REAR ELEVATION

SCALE 1/4" = 1'-0"

Foundations of exterior walls or piers exposed more than ten inches above the adjacent ground level shall be clad in the primary exterior finish material, such as lap siding, and painted to complement the primary exterior finish material.



CITY OF ROCKWALL

HISTORIC PRESERVATION ADVISORY BOARD CASE MEMO

PLANNING AND ZONING DEPARTMENT

385 S. GOLIAD STREET • ROCKWALL, TX 75087

PHONE: (972) 771-7745 • EMAIL: PLANNING@ROCKWALL.COM

TO: Historic Preservation Advisory Board

DATE: November 16, 2023

APPLICANT: Michael Cheatham; *on behalf of Jake Rashell and Nicole Smith*

CASE NUMBER: H2023-021; *Building Permit Fee Waiver for 603 E. Rusk Street*

The applicant -- *Michael Cheatham* -- is requesting the approval of a *Building Permit Fee Waiver* for the construction of an addition to an existing single-family home on the subject property. This request is being proposed in tandem with a Certificate of Appropriateness (COA) [Case No. H2023-019] and a *Small Matching Grant* [Case No. H2023-020]. On March 21, 2016, the City Council approved *Resolution No. 16-08* establishing the *Building Permit Fee Waiver Program* to provide an incentive for the rehabilitation or restoration of historic structures and other properties in certain areas of the City. For a residential property to be eligible for the *Building Permit Fee Waiver Program*, the property must be located within the Old Town Rockwall (OTR) Historic District or the Southside Residential Neighborhood Overlay (SRO) District and involve a minimum investment of \$5,000.00 for a rehabilitation or restoration project. Properties classified as Contributing (i.e. *High, Medium, or Low Contributing*) shall be eligible for a full waiver of building permit fees and properties classified as Non-Contributing shall be eligible for a reduction in permit fees of up to 50.00%. The applicant has provided a scope of work and a valuation of \$120,000.00 for the construction of the new addition and new garage. Based on the property's designation as Low-Contributing, the building permit fee would be eligible for a 100.00% reduction under the *Building Permit Fee Waiver* program. The estimated building permit fees for this project is as follows:

PERMIT	FEE
SINGLE-FAMILY [REMODEL/ADDITION]	\$487.20 [i.e. \$0.48/SF (MINIMUM FEE: \$125.00)]

Should the Historic Preservation Advisory Board (HPAB) approve the request, the total *Building Permit Fee Waiver* request would be for \$487.20. Staff should note that requests for *Building Permit Fee Waivers* are discretionary decisions for the Historic Preservation Advisory Board (HPAB). Should the Historic Preservation Advisory Board (HPAB) have any questions concerning the applicant's request, staff and the applicant will be present at the November 16, 2023 meeting.



HISTORIC PRESERVATION ADVISORY BOARD APPLICATION

City of Rockwall
Planning and Zoning Department
385 S. Goliad Street
Rockwall, Texas 75087

STAFF USE ONLY

CASE NUMBER: _____

NOTE: THE APPLICATION IS NOT CONSIDERED ACCEPTED BY THE CITY UNTIL THE PLANNING DIRECTOR HAS SIGNED BELOW.

DIRECTOR OF PLANNING: _____

DATE RECEIVED: _____

RECEIVED BY: _____

APPLICATION:

- CERTIFICATE OF APPROPRIATENESS (COA)
- LOCAL LANDMARK EVALUATION & DESIGNATION
- BUILDING PERMIT WAIVER & REDUCTION PROGRAM
- SMALL MATCHING GRANT APPLICATION

SPECIAL DISTRICTS [SELECT APPLICABLE]:

- OLD TOWN ROCKWALL HISTORIC (OTR) DISTRICT
- PLANNED DEVELOPMENT DISTRICT 50 (PD-50)
- SOUTHSIDE RESIDENTIAL NEIGHBORHOOD OVERLAY (SRO) DISTRICT
- DOWNTOWN (DT) DISTRICT

CONTRIBUTING STATUS [SELECT APPLICABLE]:

- LANDMARKED PROPERTY
- HIGH CONTRIBUTING PROPERTY
- MEDIUM CONTRIBUTING PROPERTY
- LOW CONTRIBUTING PROPERTY
- NON-CONTRIBUTING PROPERTY

CURRENT LAND USE OF THE SUBJECT PROPERTY:

- RESIDENTIAL
- COMMERCIAL

PROPERTY INFORMATION [PLEASE PRINT]

ADDRESS **603 EAST RUSK ST ROCKWALL TX 75087**

SUBDIVISION _____

LOT _____

BLOCK _____

OWNER/APPLICANT/AGENT INFORMATION [PLEASE PRINT/CHECK THE PRIMARY CONTACT/ORIGINAL SIGNATURES ARE REQUIRED]

IS THE OWNER OF THE PROPERTY THE PRIMARY CONTACT? YES NO

APPLICANT(S) IS/ARE: OWNER TENANT NON-PROFIT RESIDENT

CHECK THIS BOX IF OWNER AND APPLICANT ARE THE SAME.

OTHER, SPECIFY: _____

OWNER(S) NAME **JAKE RASHELL / NICOLE SMITH**

APPLICANT(S) NAME **MICHAEL CHEATHAM**

ADDRESS **603 EAST RUSK ST ROCKWALL**

ADDRESS **1821 TRAIL DR ROCKWALL TX**

PHONE **972-750-8802 / 208-791-9225**

PHONE **469-734-6055**

E-MAIL **JAVERASHELL@GMAIL.COM
SMITHNCL01@GMAIL.COM**

E-MAIL **OFFICE@WILLOWCREEKCUSTOMHOMES.COM**

SCOPE OF WORK/REASON FOR EVALUATION REQUEST [PLEASE PRINT]

CONSTRUCTION TYPE [CHECK ONE]:

EXTERIOR ALTERATION

NEW CONSTRUCTION

ADDITION

DEMOLITION

RELOCATIONS

OTHER, SPECIFY: _____

ESTIMATED COST OF CONSTRUCTION/DEMOLITION OF THE PROJECT (IF APPLICABLE):

\$ 120,000

PROJECT DESCRIPTION. IN THE SPACE PROVIDED BELOW OR ON A SEPARATE SHEET OF PAPER, DESCRIBE IN DETAIL THE WORK THAT WILL BE PERFORMED ON SITE. FOR LOCAL LANDMARK EVALUATION & DESIGNATION REQUESTS INDICATE ANY ADDITIONAL INFORMATION YOU MAY HAVE CONCERNING THE PROPERTY, HISTORY, SIGNIFICANCE, PRESENT CONDITIONS, STATUS, CURRENT OR PAST USE(S), ETC. STAFF RECOMMENDS THAT PHOTOGRAPHS OF THE INTERIOR AND EXTERIOR OF THE PROPERTY ARE SUBMITTED WITH THIS APPLICATION.

ADDING ROUGHLY 615 SF OF AIR CONDITIONED SPACE TO BACK OF HOME. 375 SF TO BE LIVING ROOM & 240 SF TO BE BEDROOM & CLOSET. ADDING A 400 SF 2 CAR GARAGE TO RIGHT SIDE OF HOME. ALL NEW EXTERIOR FACADE TO MATCH EXISTING EXCEPT POSSIBLY USING A HARDY SIDING ON BACK NOT EXPOSED TO STREET IF ALLOWED.

OWNER & APPLICANT STATEMENT [ORIGINAL SIGNATURES REQUIRED]

I ACKNOWLEDGE THAT I HAVE READ THIS APPLICATION AND THAT ALL INFORMATION CONTAINED HEREIN IS TRUE AND CORRECT TO THE BEST OF MY KNOWLEDGE. FURTHERMORE, I UNDERSTAND THAT IT IS NECESSARY FOR ME OR A REPRESENTATIVE TO BE PRESENT AT A PUBLIC HEARING FOR THIS CASE TO BE APPROVED.

OWNER'S SIGNATURE _____

APPLICANT'S SIGNATURE **[Signature]**



H2023-021: Building Permit Fee Waiver for 603 E Rusk Street



Case Location Map = 



City of Rockwall

Planning & Zoning Department
385 S. Goliad Street
Rockwall, Texas 75087
(P): (972) 771-7745
(W): www.rockwall.com

The City of Rockwall GIS maps are continually under development and therefore subject to change without notice. While we endeavor to provide timely and accurate information, we make no guarantees. The City of Rockwall makes no warranty, express or implied, including warranties of merchantability and fitness for a particular purpose. Use of the information is the sole responsibility of the user.





City of Rockwall

Planning & Zoning Department
385 S. Goliad Street
Rockwall, Texas 75087
(P): (972) 771-7745
(W): www.rockwall.com

The City of Rockwall GIS maps are continually under development and therefore subject to change without notice. While we endeavor to provide timely and accurate information, we make no guarantees. The City of Rockwall makes no warranty, express or implied, including warranties of merchantability and fitness for a particular purpose. Use of the information is the sole responsibility of the user.

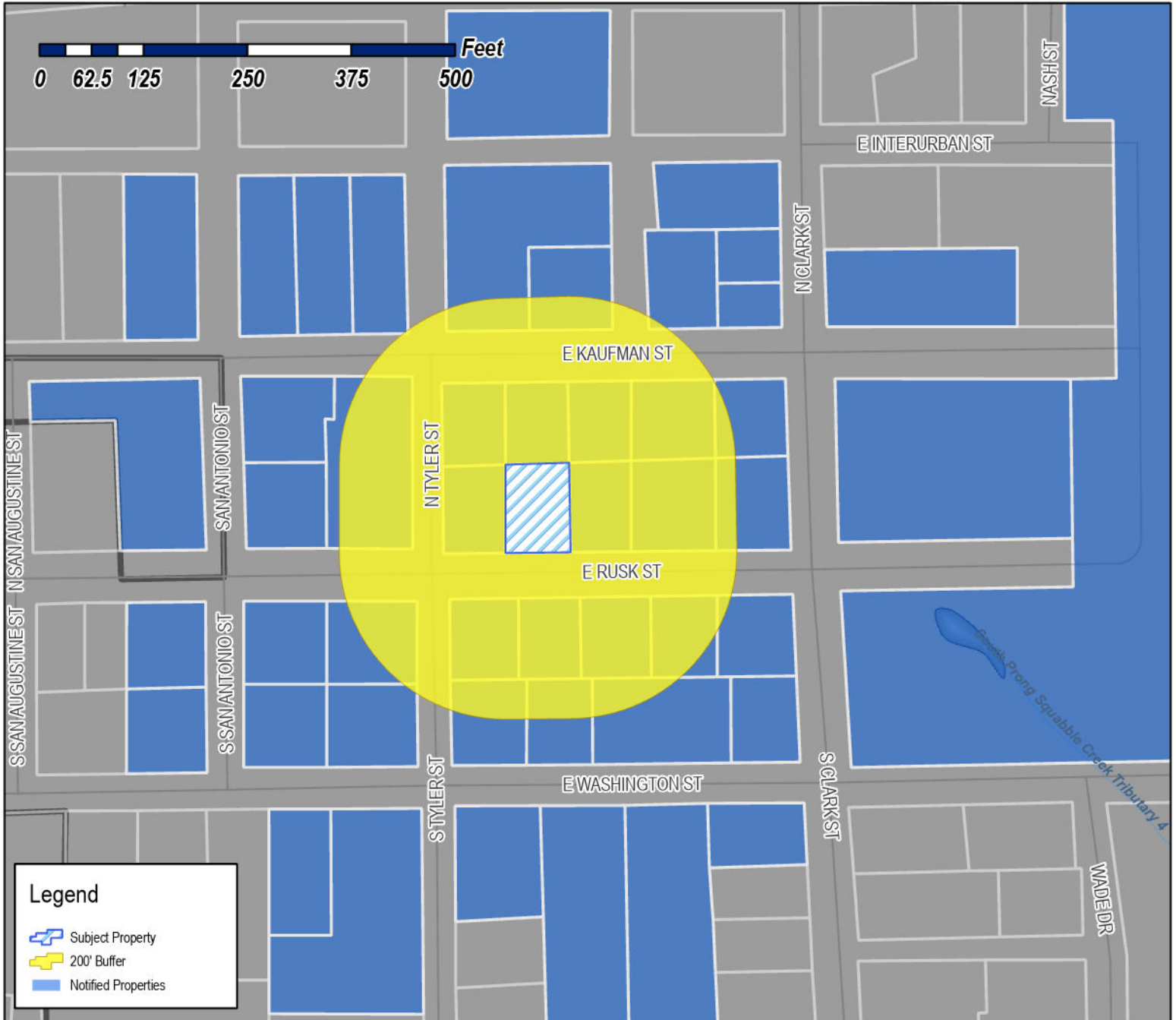

Case Number: H2023-021
Case Name: Building Permit Fee Waiver for 603 E Rusk Street
Case Type: Historic
Zoning: Single-Family 7 (SF-7) District
Case Address: 603 E Rusk Street

Date Saved: 10/30/2023

For Questions on this Case Call: (972) 771-7746

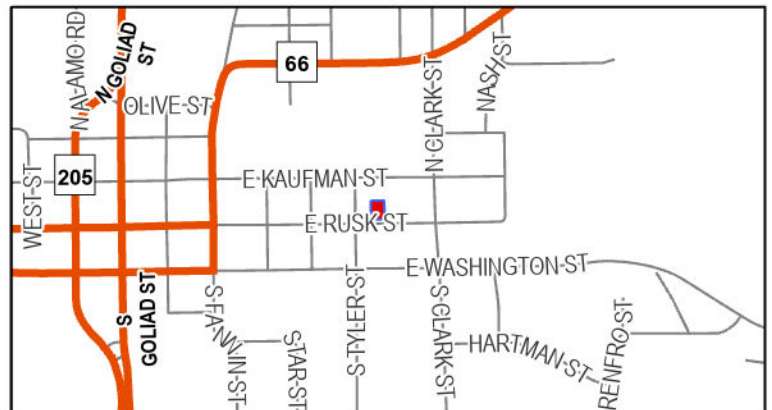

SMILEY KAREN APRIL
605 E RUSK ST
ROCKWALL, TX 75087

INDEPENDENT ADMINISTRATOR - ESTATE OF
ROBERT THOMAS WIKTORCH
P.O. BOX 3061
WARMINSTER, PA 18974

DUTT JOHN RICHARD JR ETUX
505 E WASHINGTON ST
ROCKWALL, TX 75087

BIRKENBACK JOSSEPH M & OLGA M
506 E RUSK ST
ROCKWALL, TX 75087

CLARK JENNIFER A
610 E KAUFMAN ST
ROCKWALL, TX 75087

GALVAN CARMAN
604 E KAUFMAN ST
ROCKWALL, TX 75087

OCCUPANT
603 E RUSK ST
ROCKWALL, TX 75087

INTEGRITY ALL CASH HOME BUYERS LLC
7340 BAKER BLVD #392
RICHLAND HILLS, TX 76118

ROCKWALL COMMUNITY PLAYHOUSE
609 E RUSK ST
ROCKWALL, TX 75087

OCCUPANT
601 E WASHINGTON ST
ROCKWALL, TX 75087

GLASS JERRY
301 MEADOWDALE DR
ROCKWALL, TX 75087

GREEN JAMES KEITH II & HOLLY NICOLE
605 E WASHINGTON ST
ROCKWALL, TX 75087

ROCKWALL COMMUNITY PLAYHOUSE
609 E RUSK ST
ROCKWALL, TX 75087

REEVES ASHLEY ELLEN & DANIEL GARRET
609 E WASHINGTON ST
ROCKWALL, TX 75087

WEBB RODNEY D AND FRAN W
507 E RUSK ST
ROCKWALL, TX 75087

HARPER VICKI DAWSON
605 E KAUFMAN ST
ROCKWALL, TX 75087

OCCUPANT
601 E KAUFMAN ST
ROCKWALL, TX 75087

HARPER LYDIA
1200 CLEVELAND STREET APT 327
DENTON, TX 76201

HARPER VICKI DAWSON
605 E KAUFMAN ST
ROCKWALL, TX 75087

ROCKWALL COMMUNITY PLAYHOUSE
609 E RUSK ST
ROCKWALL, TX 75087

COUNTY OF ROCKWALL
101 E Rusk ST
ROCKWALL, TX 75087

WILLIAMS JERRY LANE
608 E RUSK ST
ROCKWALL, TX 75087

SMITH GREGORY P & MARILYN
610 E RUSK ST
ROCKWALL, TX 75087

ROBINSON NELDA
602 E RUSK ST
ROCKWALL, TX 75087

HORNER ANDREA J
604 E RUSK ST
ROCKWALL, TX 75087

OCCUPANT
102 S CLARK ST
ROCKWALL, TX 75087

KINSEY DONALD H & TARI L
2 MANOR COURT
HEATH, TX 75032

OCCUPANT
601 E RUSK ST
ROCKWALL, TX 75087

QUINTON BILLY & AUTUMN
102 N TYLER ST
ROCKWALL, TX 75087

QUINTON BILLY & AUTUMN
102 N TYLER ST
ROCKWALL, TX 75087

OCCUPANT
505 E KAUFMAN ST
ROCKWALL, TX 75087

BALL JUSTIN
2155 CLUBVIEW DR
ROCKWALL, TX 75087

PUBLIC NOTICE



CITY OF ROCKWALL
PLANNING AND ZONING DEPARTMENT
PHONE: (972) 771-7745
EMAIL: PLANNING@ROCKWALL.COM

Property Owner and/or Resident of the City of Rockwall:

You are hereby notified that the Historic Preservation Advisory Board will consider the following application:

Case No. H2023-021: Building Permit Fee Waiver for 603 E. Rusk Street

Hold a public hearing to discuss and consider a request by Michael Cheatham on behalf of Jake Rashell and Nicole Smith for the approval of a Building Permit Fee Waiver for an addition to an existing single-family home being a Low Contributing Property on a 0.25-acre parcel of land identified as Block 120E of the B. F. Boydston Addition, City of Rockwall, Rockwall County, Texas, zoned Single-Family 7 (SF-7) District, situated within the Old Town Rockwall (OTR) Historic District, addressed as 603 E. Rusk Street, take any action necessary.

For the purpose of considering the effects of such a request, the Historic Preservation Advisory Board will hold a public hearing on Thursday, November 16, 2023 at 6:00 PM. This hearing will be held in the City Council Chambers at City Hall, 385 S. Goliad Street.

As an interested property owner, you are invited to attend these meetings. If you prefer to express your thoughts in writing please return the form to:

Angelica Guevara
Rockwall Planning and Zoning Dept.
385 S. Goliad Street
Rockwall, TX 75087

You may also email your comments to the Planning Department at planning@rockwall.com. If you choose to email the Planning Department please include your name and address for identification purposes.

Your comments must be received by Thursday, November 16, 2023 at 4:00 PM to ensure they are included in the information provided to the Historic Preservation Advisory Board.

Sincerely,

Ryan Miller, AICP
Director of Planning & Zoning

----- PLEASE RETURN THE BELOW FORM -----

Case No. H2023-021: Building Permit Fee Waiver for 603 E. Rusk Street

Please place a check mark on the appropriate line below:

I am in favor of the request for the reasons listed below.

I am opposed to the request for the reasons listed below.

Four horizontal grey bars for providing reasons for support or opposition.

Name:

Grey bar for Name

Address:

Grey bar for Address

Tex. Loc. Gov. Code, Sec. 211.006 (d) If a proposed change to a regulation or boundary is protested in accordance with this subsection, the proposed change must receive, in order to take effect, the affirmative vote of at least three-fourths of all members of the governing body. The protest must be written and signed by the owners of at least 20 percent of either: (1) the area of the lots or land covered by the proposed change; or (2) the area of the lots or land immediately adjoining the area covered by the proposed change and extending 200 feet from that area.

PLEASE SEE LOCATION MAP OF SUBJECT PROPERTY ON THE BACK OF THIS NOTICE



TRACT 2
BILLY QUINTON AND
AUTUMN QUINTON
INST. NO.
20160000012152

CARMEN GALVAN
VOL. 1907, PG. 137

(CM)
N.E. CORNER OF
CARMEN GALVAN
VOL. 1907, PG. 137

VICTORY WORSHIP
CENTER, INC.
VOL. 1395, PG. 142

1/2" IRF FOR REFERENCE
S 01°31'27" E - 0.38'

N 89°44'24" E 75.00'

100.00'

N 01°31'27" W

100.00'

TRACT 1
BILLY QUINTON AND
AUTUMN QUINTON
INST. NO.
20160000012152

7,498 sq. ft.
0.17 of an acre

ONE STORY
FRAME NO
FOUNDATION

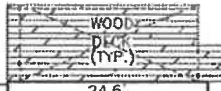

ONE STORY
FRAME
(603)

ROBERT THOMAS
WIKTORCHIK
INST. NO.
2007-00381305

(CM)
S.W. CORNER OF
TRACT 1
BILLY QUINTON AND
AUTUMN QUINTON
INST. NO.
20160000012152

75.00' S 89°44'24" W 75.00'

PLACE OF
BEGINNING

OHPL OHPL OHPL OHPL OHPL

ASPHALT

E. RUSK STREET



TRACT 2
BILLY QUINTON AND
AUTUMN QUINTON
INST. NO.
20160000012152

CARMEN GALVAN
VOL. 1907, PG. 137

VICTORY WORSHIP
CENTER, INC.
VOL. 1395, PG. 142

1/2" IRF FOR REFERENCE
S 01°31'27" E - 0.38'

(CM)
N.E. CORNER OF
CARMEN GALVAN
VOL. 1907, PG. 137

TRACT 1
BILLY QUINTON AND
AUTUMN QUINTON
INST. NO.
20160000012152

ROBERT THOMAS
WIKTORCHIK
INST. NO.
2007-00381305

(CM)
S.W. CORNER OF
TRACT 1
BILLY QUINTON AND
AUTUMN QUINTON
INST. NO.
20160000012152

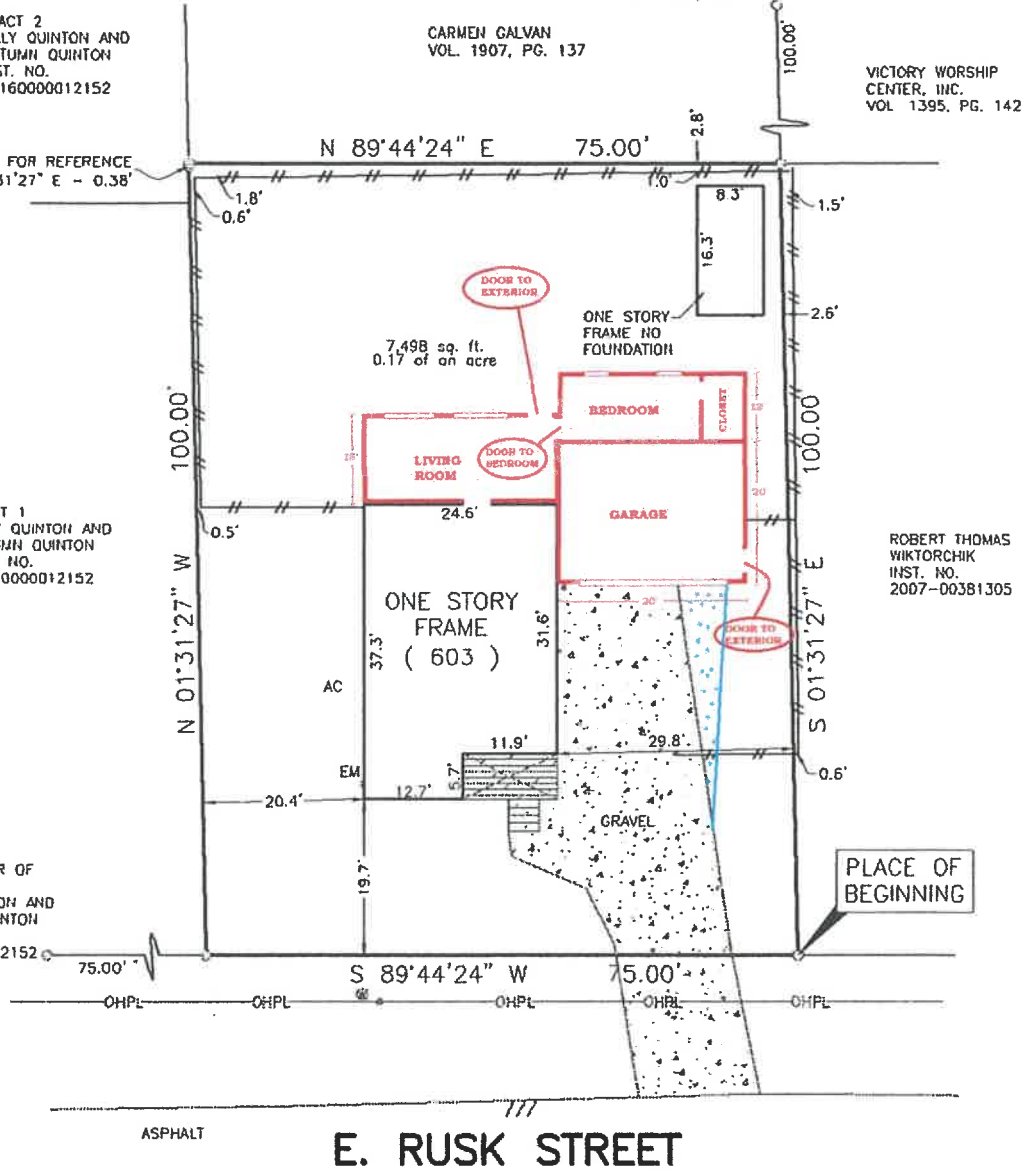



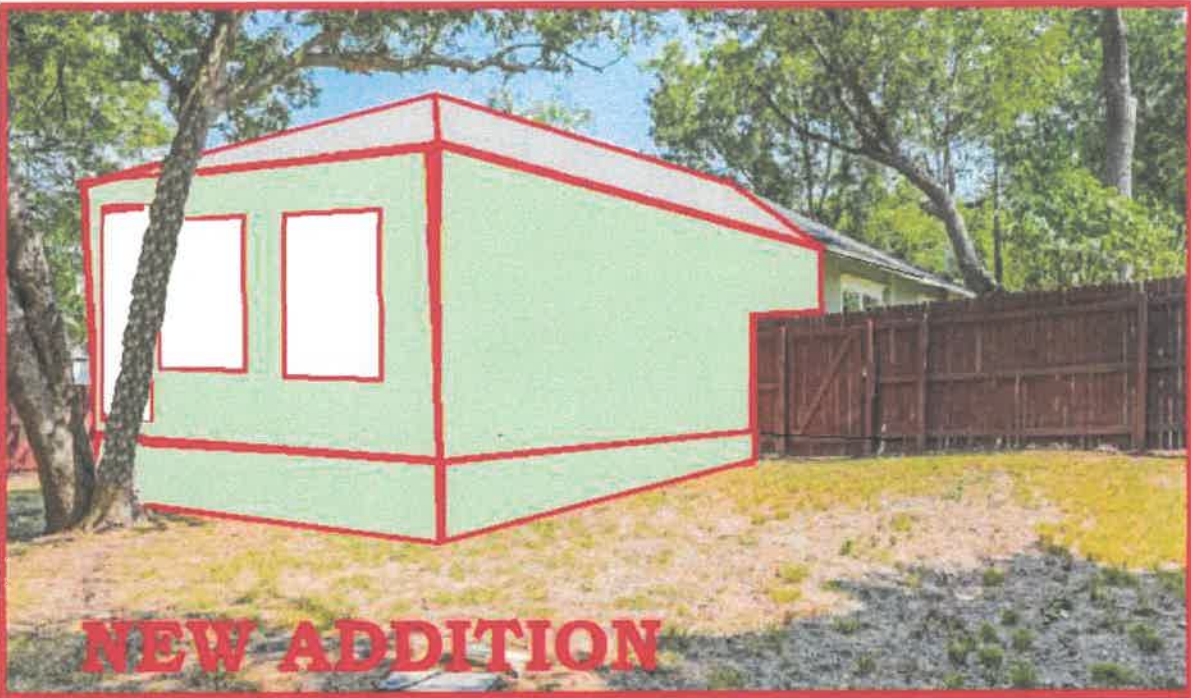

NEW ADDITION



EXISTING

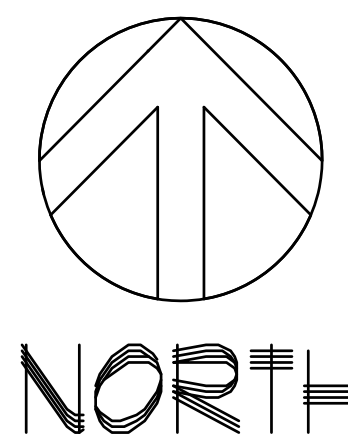
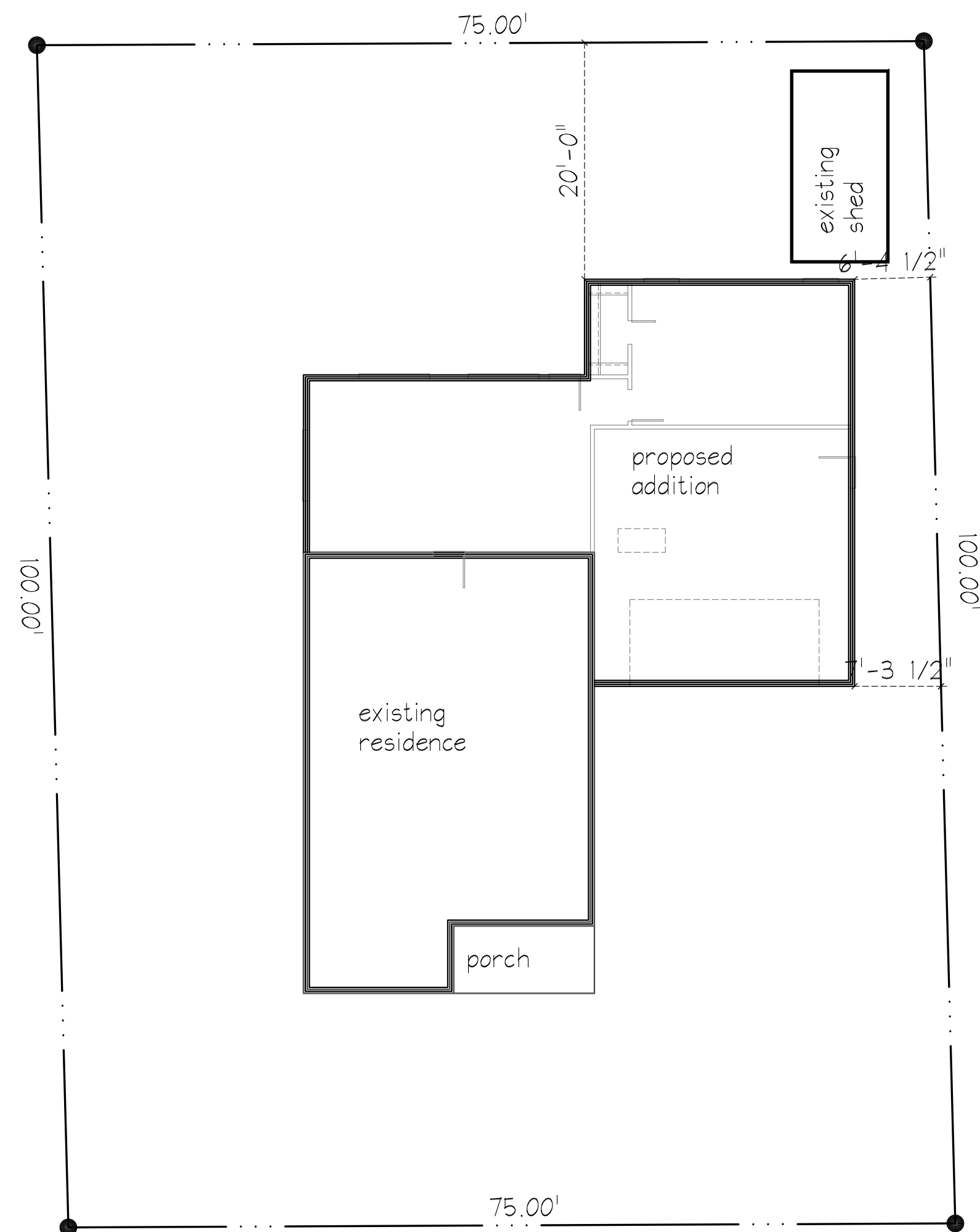

Areas:

Area of Lot	7,498 sq. ft.
Covered Area	1,142 sq. ft.
Percent Covered	15.2%

PLOT PLAN
SCALE 1" = 10'-0"

Notes:

- Do not scale drawings, follow dimensions only. All structural information shown for reference purposes only. Contractor shall have licensed structural engineer review and design all structural elements such as all framing walls, beams, connections, headers, joists and rafters.
- All dimensions are from face of stud to face of stud unless otherwise noted.
- Window sizes indicated on plans are noted by approximate rough openings size. Verify window sizes and "owner furnish windows" with owner prior to construction. Refer to plans and exterior elevations for window types.
- All framing shall be done in accordance with IBC latest edition.
- Spread studs at tub ends to accommodate plumbing and provide blocking, top and bottom, at shower to secure plumbing.
- Exterior sheathing shall be 5/8" OSB.
- All interior walls shall be covered with 1/2" gypsum board with metal corner reinforcing. Drywall finish should include taping over joints, applying joint compound and sanding the compound for a smooth finish. Verify with owner the level of drywall texturing.
- All walls and ceilings in garage and garage storage areas to have 5/8" Type-X gypsum board with 1-hour fire rating. All exterior doors in garage and attic access to be metal or solid core with a 20 minute fire rating.
- Provide 1/2" "moisture resistant" gypsum board at all wet locations.
- All finishes to be chosen and verified by owner.
- Contractor shall field verify all cabinet dimensions before fabrication.
- All millwork to be chosen and verified by owner. Contractor shall submit "shop drawings" at owners request.
- Provide 1/2" cement board for tile backer.
- Provide min. 4 - gang 2x4 studs at glue-lam bearing.
- All work shall be in accordance with National Plumbing Code, Latest Edition.
- Contractor shall provide HVAC "duct layout" for approval prior to fabrication. For coordination with fixtures and diffuser location.
- Verify all column type, size, and material with owner prior to construction.
- Prefabricated fireplace construction shall meet or exceed all applicable codes regarding use of fire separations, clearances, etc. It is the contractor's responsibility to ensure that all items and construction meet or exceed code. Overall flue height shall be coordinated to match height shown on plans and shall not exceed the top of chimney chase as constructed. All fireplace chase walls shall be insulated inside and outside. Provide horizontal "draft stops" at each floor level by packing 6" (R19) insulation between 2x4 joists.
- Provide combustion air vents with screen and back damper for fireplaces, wood stoves and any appliance with an open flame.
- All bath and toilet area walls shall have water resistant gypsum boards.
- All plumbing walls shall be 2x6.
- Bedroom windows shall have a minimum net clear opening of 5.7 square feet, a minimum net clear openable width of 20", a minimum net clear openable height of 24", and have a maximum finish sill height of 42" from finished floor. All glass located within 18" of floor, 24" of a door or located within 60" of floor at bath tubs, whirlpools, showers, saunas, steam rooms, or hot tubs shall be tempered.
- Attic HVAC units shall be located within 20' of its service opening. Return air grills shall not be located within 10' of a gas fired appliance.
- All exposed insulation shall have a flame spread rating of less than 25 and a smoke density rating of less than 450.

MASTER REVISION INDEX			APPLICABLE CODES
SHEET #	DESCRIPTION	SCALE	
1	PLOT PLAN	1"=10'-0"	2021 INTERNATIONAL FIRE CODE
2	DEMO PLAN & REMODEL PLAN W/ ELECTRICAL	1/4"=1'-0"	2021 INTERNATIONAL BUILDING CODE
3	FOUNDATION LAYOUT & ROOF PLAN	1/4"=1'-0"	2021 INTERNATIONAL PLUMBING CODE
4	FRONT, REAR, LEFT, & RIGHT ELEVATION	1/4"=1'-0"	2020 NATIONAL ELECTRICAL CODE
5	STANDARD DETAILS	N.T.S.	2021 INTERNATIONAL RESIDENTIAL CODE
			2021 INTERNATIONAL ENERGY CONSERVATION CODE
			2021 INTERNATIONAL FUEL & GAS CODE
			2021 INTERNATIONAL GREEN CONSTRUCTION CODE

REVISIONS:

11/02/2023

J. Karlovich
Home Design
(214) 674-0290 : Phone
jkarlovichhomedesign.com

These plans are intended to provide the basis construction information necessary to substantially complete the structure. Like most home designers, this firm, J. Karlovich Home Design, is not being an architectural or engineering firm stands no liability for structural or architectural design integrity. Every effort has been made to ensure all dimensions are correct and governmental regulations have been met. If any error or omission does occur it is the sole responsibility of the contractor and/or the owner to correct the error and/or omission at his own expense and not the responsibility of J. Karlovich Home Design. These plans are intended to be a one-time use for this address ONLY.

Willow Creek Custom Homes
469-338-0141

A Custom Addition for:
Jake Rashell & Nicole Smith
603 E Rusk Street
Abstract No. 14
B.F. Boydston Survey
City of Rockwall, Rockwall County, Texas

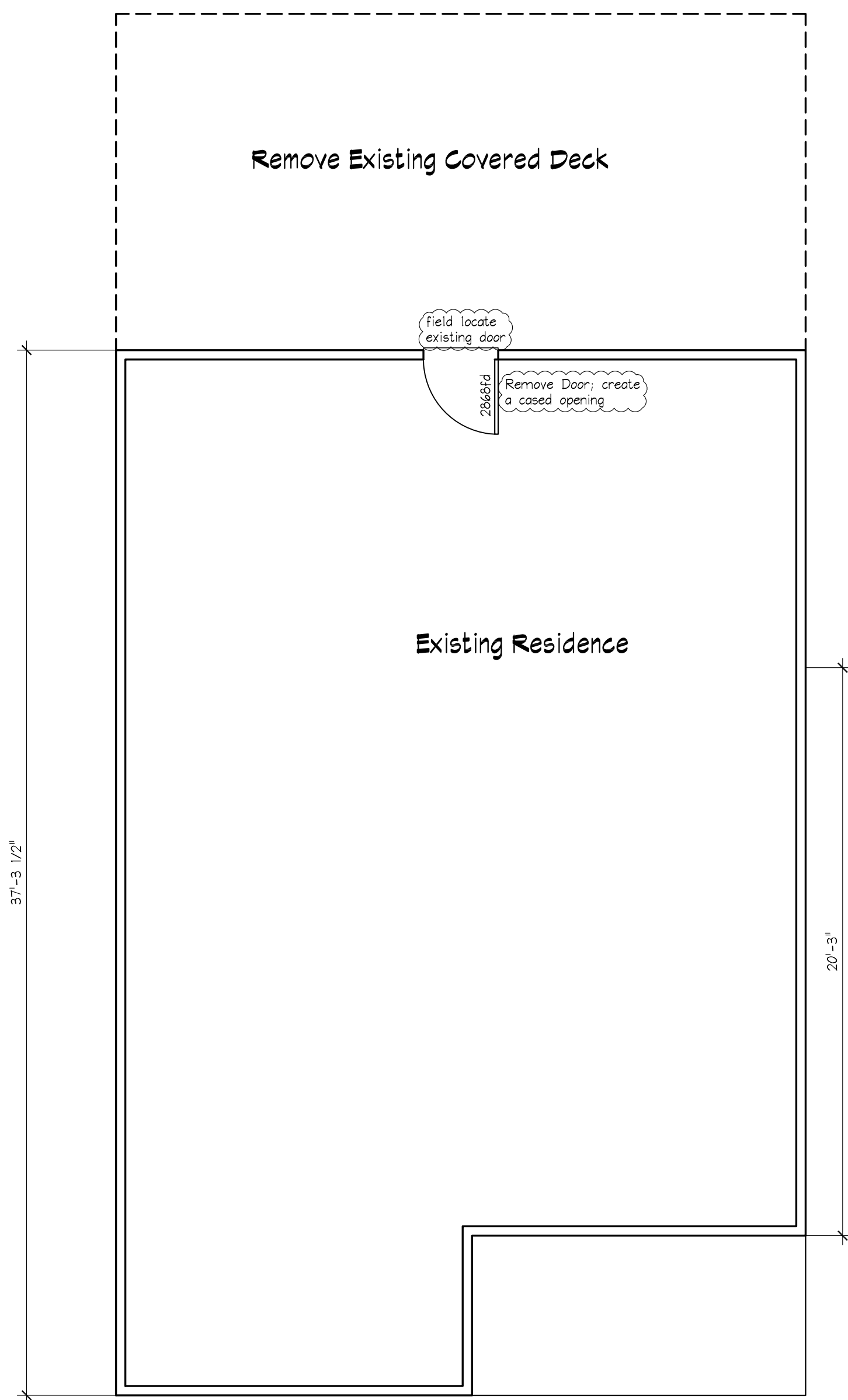

EXISTING + DEMO PLAN
SCALE 1/4" = 1'-0"

ELECTRICAL LEGEND	
⊕	Surface/Ceiling Mount
⊙	Recessed Eyeball Mount
⊕	Ground-up Landscape Flood
⊕	Wall Mounted
⊕	6" LED Recessed Can Light
⊕	6" Vapor Recessed Can Light
⊕	Single Fluorescent Strip
⊕	Double Flood w/ Motion Sensor (exterior)
⊕	LED Fluorescent Lighting
⊕	Exhaust Fan (minimum 90 cfm)
⊕	Ceiling Heater
⊕	Carbon Monoxide Detector
⊕	Sub Panel
⊕	Intercomm System
⊕	Telephone Jack
⊕	Bundled Cable (2 RG6 Coax, 2 CAT6, 2 Fiber)
⊕	Network (CAT6 Only)
⊕	Speaker (1/4" Speaker Wiring)
⊕	Smoke and Carbon Monoxide Detector
⊕	Duplex Outlet (125 volt)
⊕	Appliance Outlet (240 volt)
⊕	GFI Outlet (UL Approved)
⊕	Ceiling Outlet (125 volt)
⊕	Floor Outlet (pre-wire before pouring foundation)
⊕	Single Light Switch
⊕	Three Way Light Switch
⊕	Light Switch with Dimmer Control
⊕	Ceiling Fan (provide proper ceiling brace)
⊕	Electrical Breaker Box (refer to electrician for size)

Notes:

- All electrical work shall be done in accordance with National Electric Code, Latest Edition.
- Provide a J-Box below counter for dishwasher, ice machine, compactor and range.
- Provide waterproof covers on all exterior outlets and ground fault interrupter receptacles in all wet and exterior locations.
- All fixtures shall be UL Approved.
- Provide "bustion" at entry doors and door chimes.
- Verify water heater and HVAC electrical requirements prior to construction.
- Verify all outlet, switch, fixture, television and telephone locations with owner prior to construction.
- Provide light fixtures and outlets in attic as per owners instructions.
- Verify all light fixtures and plug type and location with owner prior to installation.
- Center all light fixtures in each room.

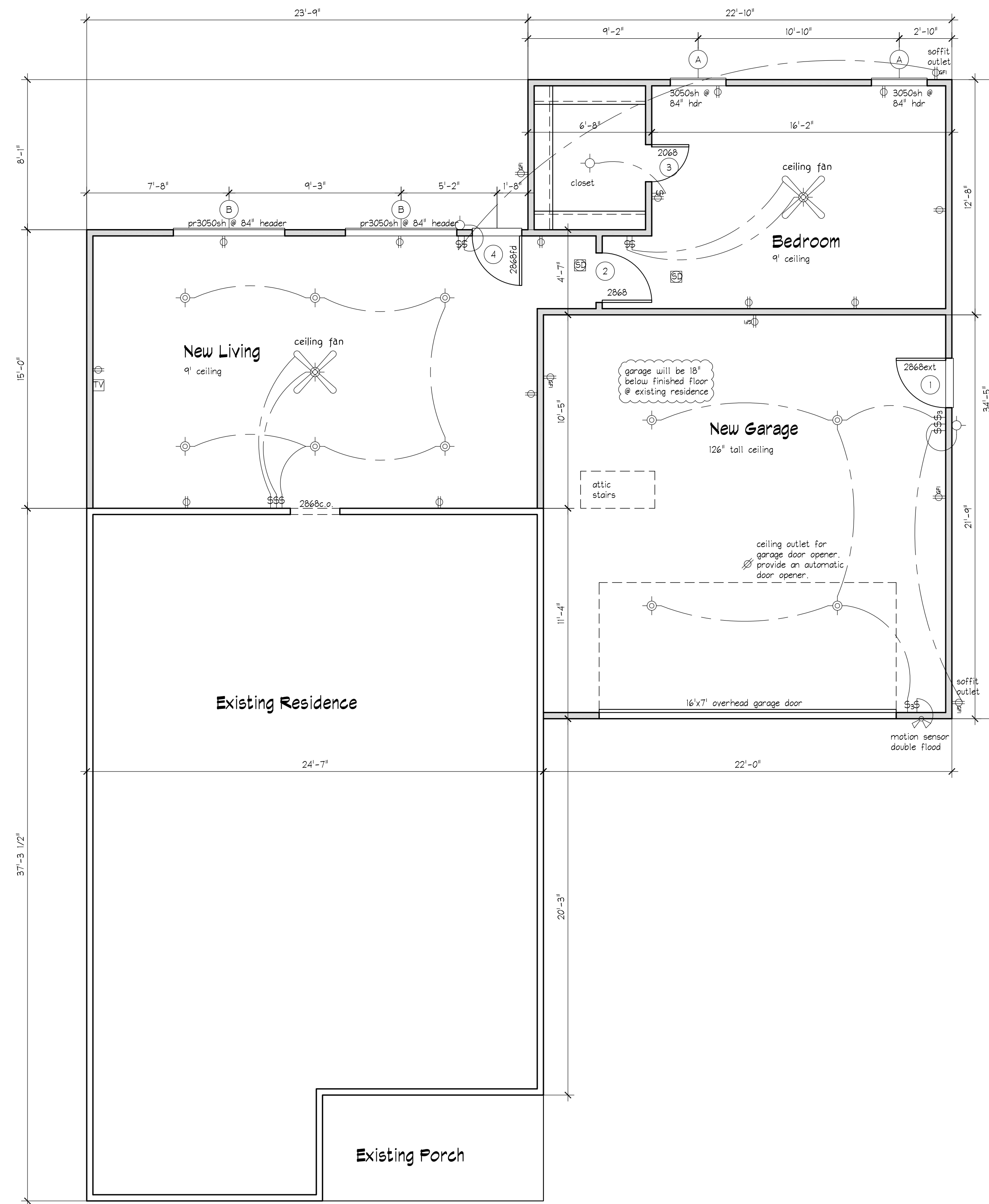

FLOOR + ELECTRICAL PLAN
SCALE 1/4" = 1'-0"

Doors Schedule:

ID#	Size	Description	Quantity
1	2868	Exterior as Selected	1
2	2868	Interior as Selected	1
3	2068	Interior as Selected	1
4	2868	Exterior 1-Lite Glass Door	1

Windows Schedule:

ID#	Size	Description	Quantity
A	3050	Single Hung	2
B	Pair 3050	Single Hung	3

All windows in wet areas, in stairwell, and/or closer than 24" to a door to have tempered glass.

Areas:

Existing HVAC Area	850 sq. ft.
New HVAC Area	651 sq. ft.
Total HVAC Area	1,501 sq. ft.
Garage	491 sq. ft.
Existing Porch	68 sq. ft.
New Slab	1,142 sq. ft.
New Total Under Roof	2,060 sq. ft.

These plans are intended to provide the basic construction information necessary to substantially complete this structure. Like most home designs, this firm, J. Karlovich Home Design, is not being an architectural or engineering firm stands no liability for structural or architectural design integrity. Every effort has been made to ensure all dimensions are correct and governmental regulations have been met. If any error or omission does occur it is the sole responsibility of the contractor and/or the owner to correct the error and/or omission at his own expense and not the responsibility of J. Karlovich Home Design. These plans are intended to be a one time use for this address ONLY.





NOV 11 2004

These plans are intended to provide the basic construction information necessary to substantially complete this structure. Like most home designers, this firm, J. Karlovich Home Design, is not an architectural or engineering firm and stands no liability for structural or architectural design integrity. Every effort has been made to ensure all dimensions are correct and governmental regulations have been met. If any error or omission does occur it is the sole responsibility of the contractor and/or the owner to correct the error and/or omission at his own expense and not the responsibility of J. Karlovich Home Design. These plans are intended to be a one-time use for this address ONLY.

Willow Creek Custom Homes
469-338-0141

A Custom Addition for:
Jake Rashell & Nicole Smith

603 E Rusk Street
Abstract No. 14
B.F. Boydston Survey
City of Rockwall, Rockwall County, Texas

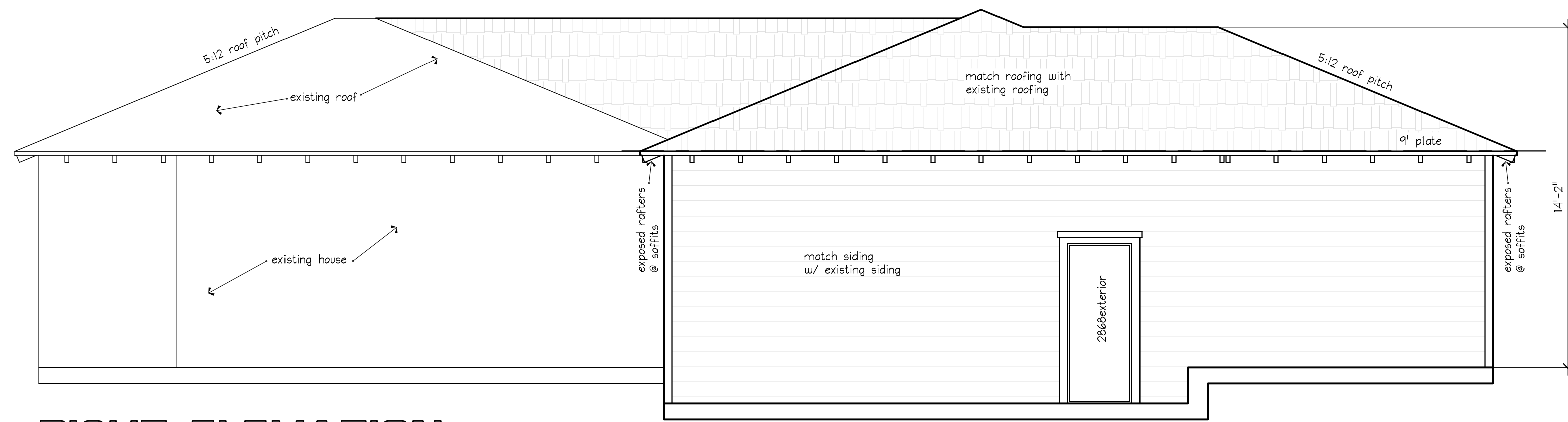

RIGHT ELEVATION

SCALE 1/4" = 1'-0"

Foundations of exterior walls or piers exposed more than ten inches above the adjacent ground level shall be clad in the primary exterior finish material, such as lap siding, and painted to complement the primary exterior finish material.

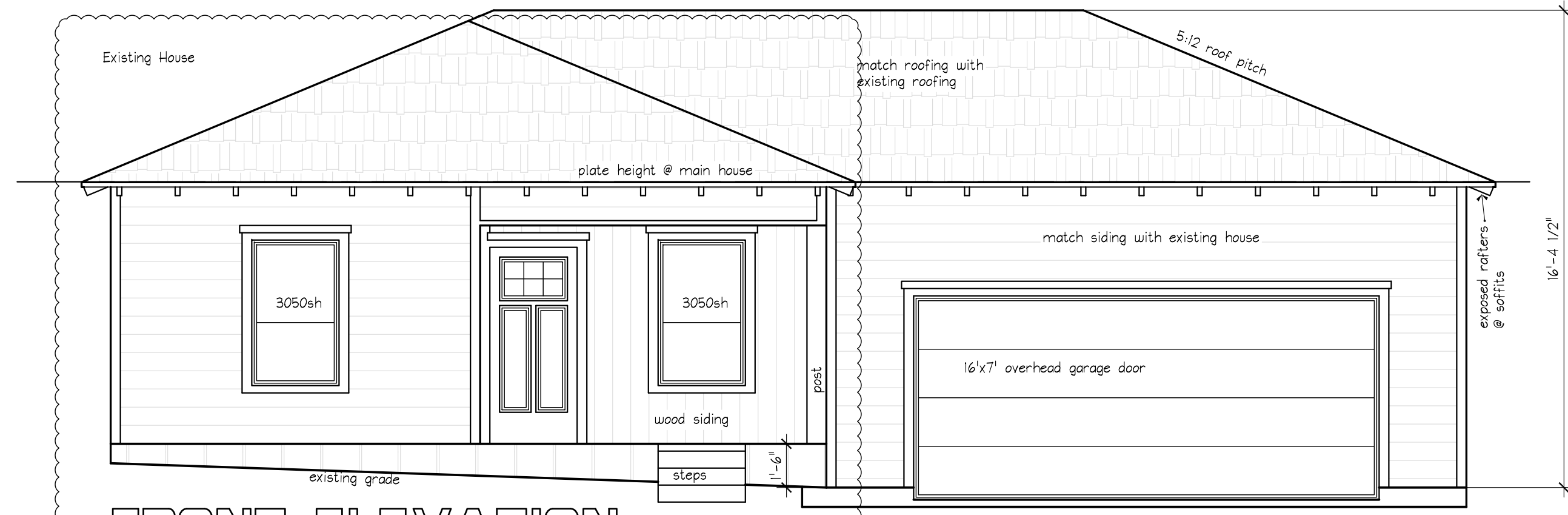

FRONT ELEVATION

SCALE 1/4" = 1'-0"

Foundations of exterior walls or piers exposed more than ten inches above the adjacent ground level shall be clad in the primary exterior finish material, such as lap siding, and painted to complement the primary exterior finish material.

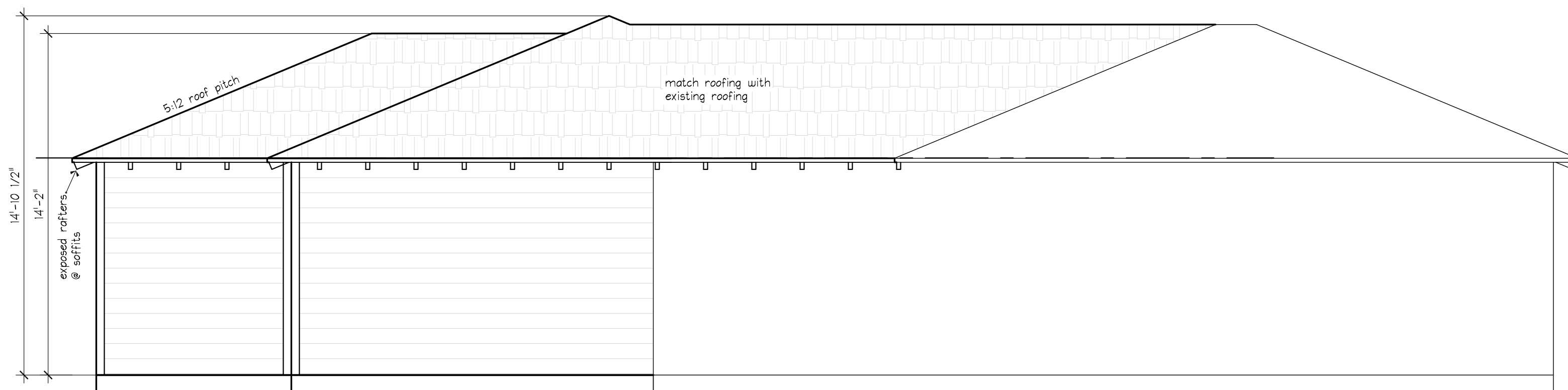

LEFT ELEVATION

SCALE 1/4" = 1'-0"

Foundations of exterior walls or piers exposed more than ten inches above the adjacent ground level shall be clad in the primary exterior finish material, such as lap siding, and painted to complement the primary exterior finish material.

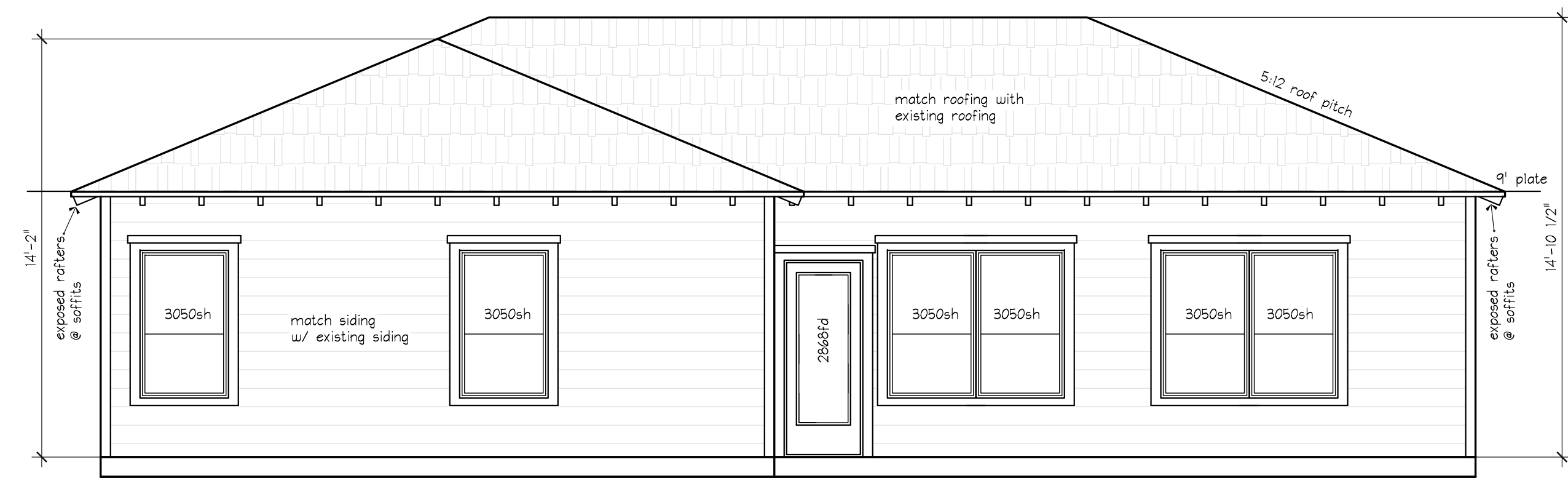

REAR ELEVATION

SCALE 1/4" = 1'-0"

Foundations of exterior walls or piers exposed more than ten inches above the adjacent ground level shall be clad in the primary exterior finish material, such as lap siding, and painted to complement the primary exterior finish material.

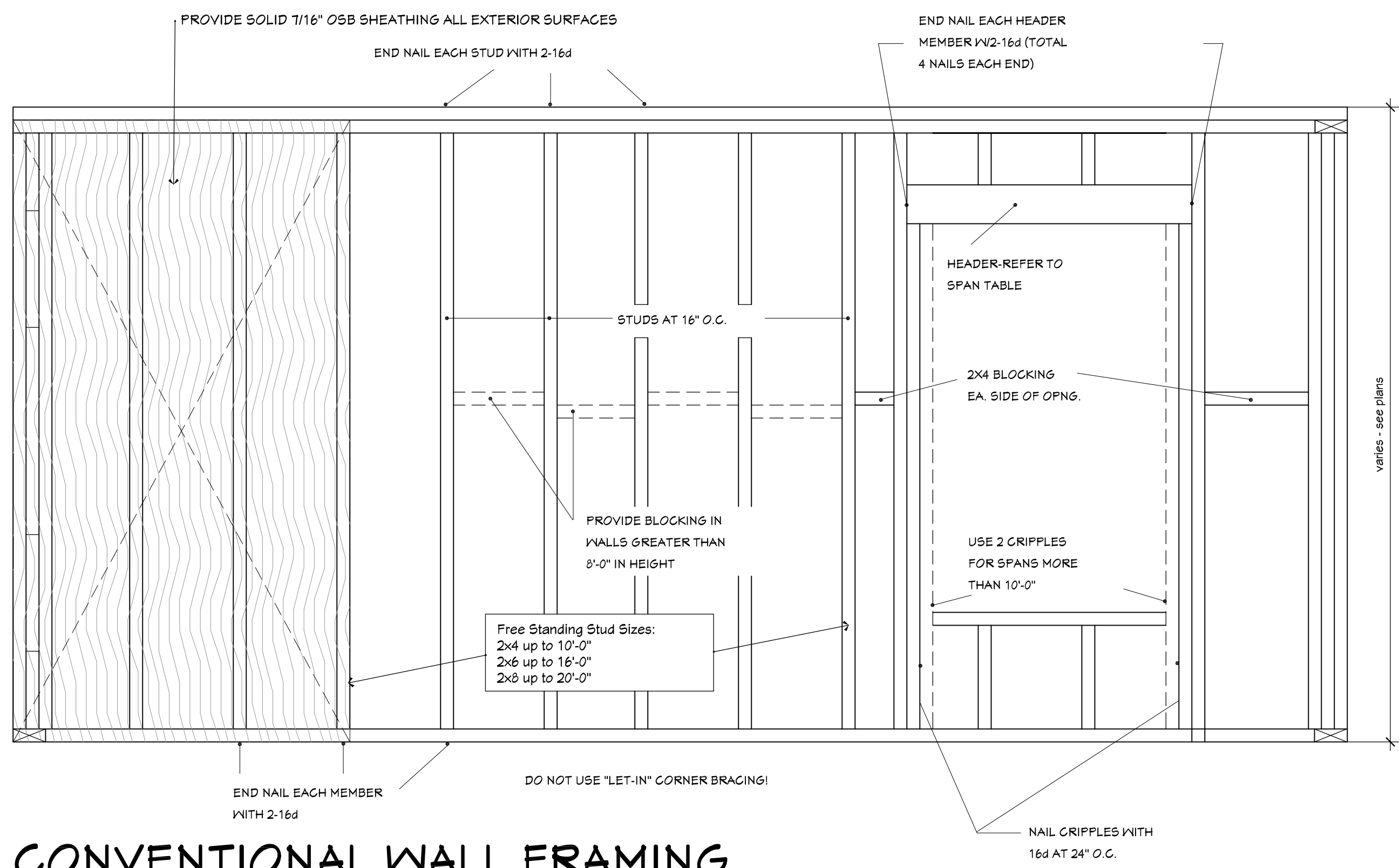

CONVENTIONAL WALL FRAMING

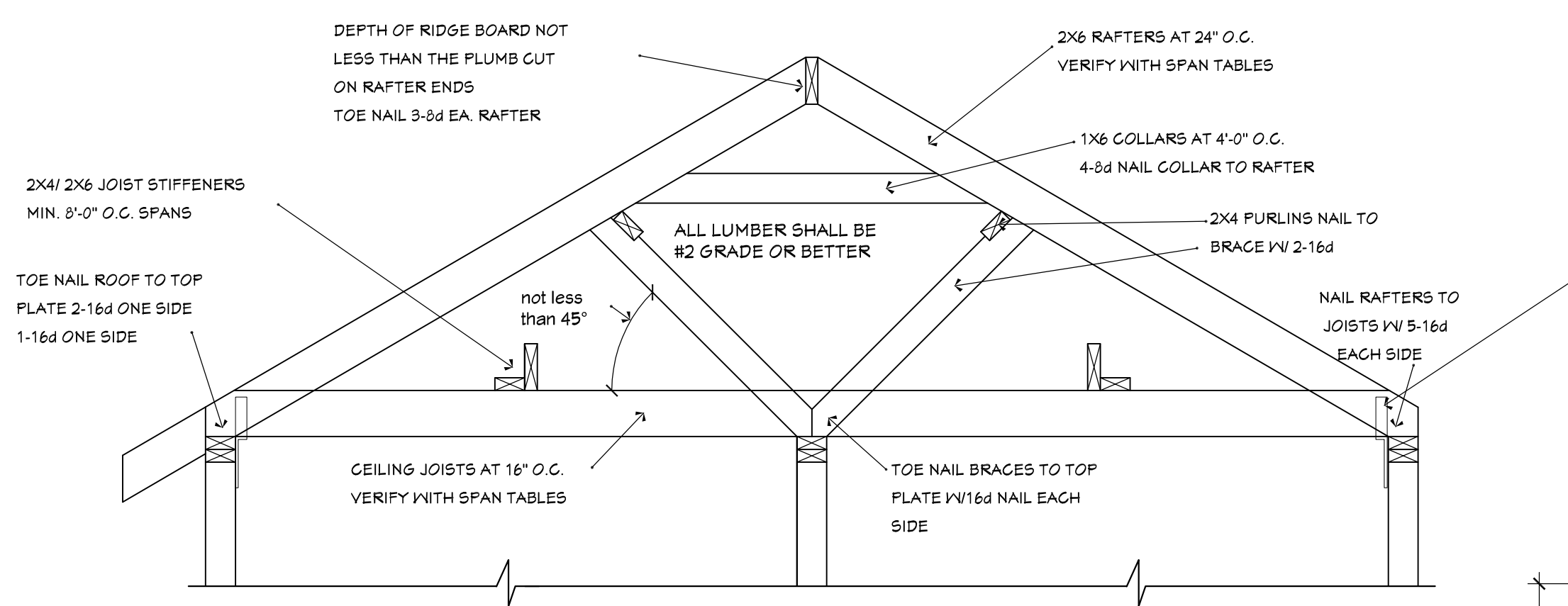

CONVENTIONAL ROOF BRACING

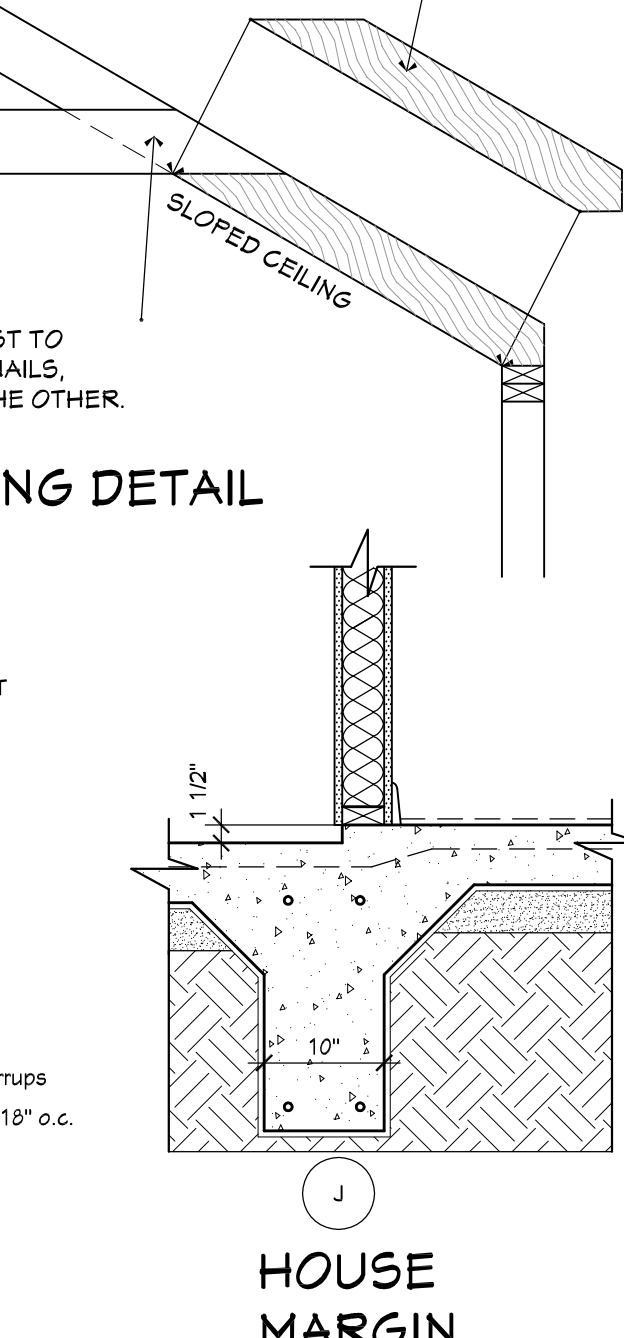
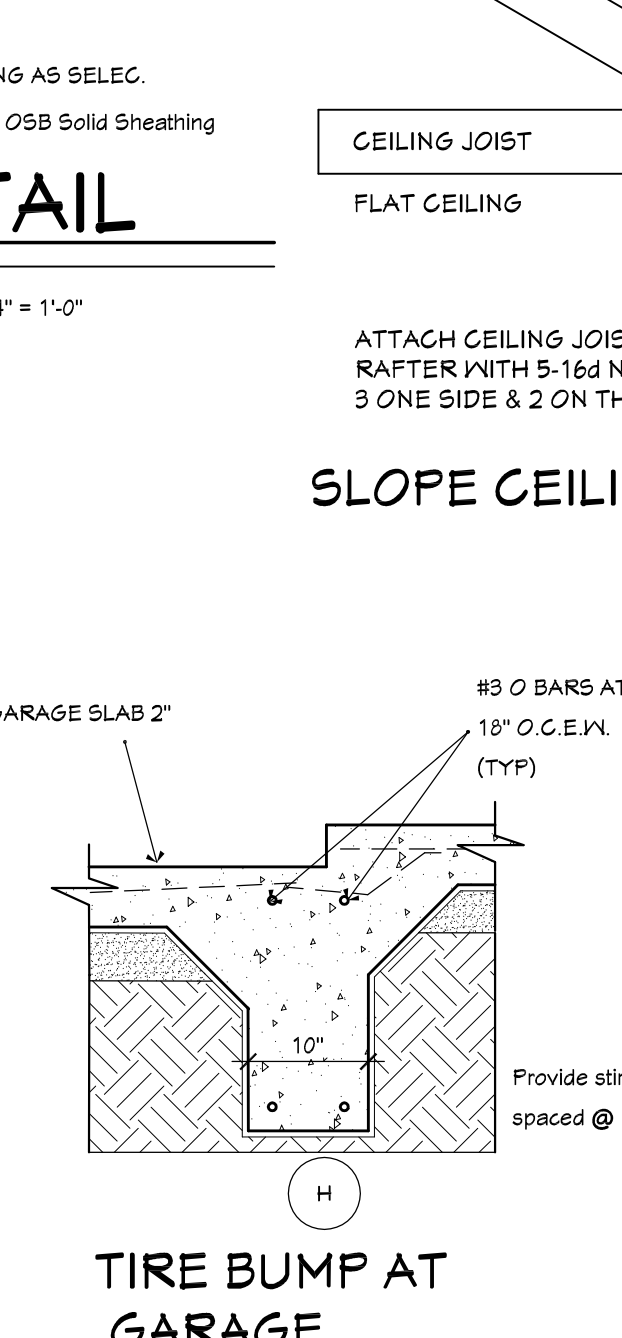
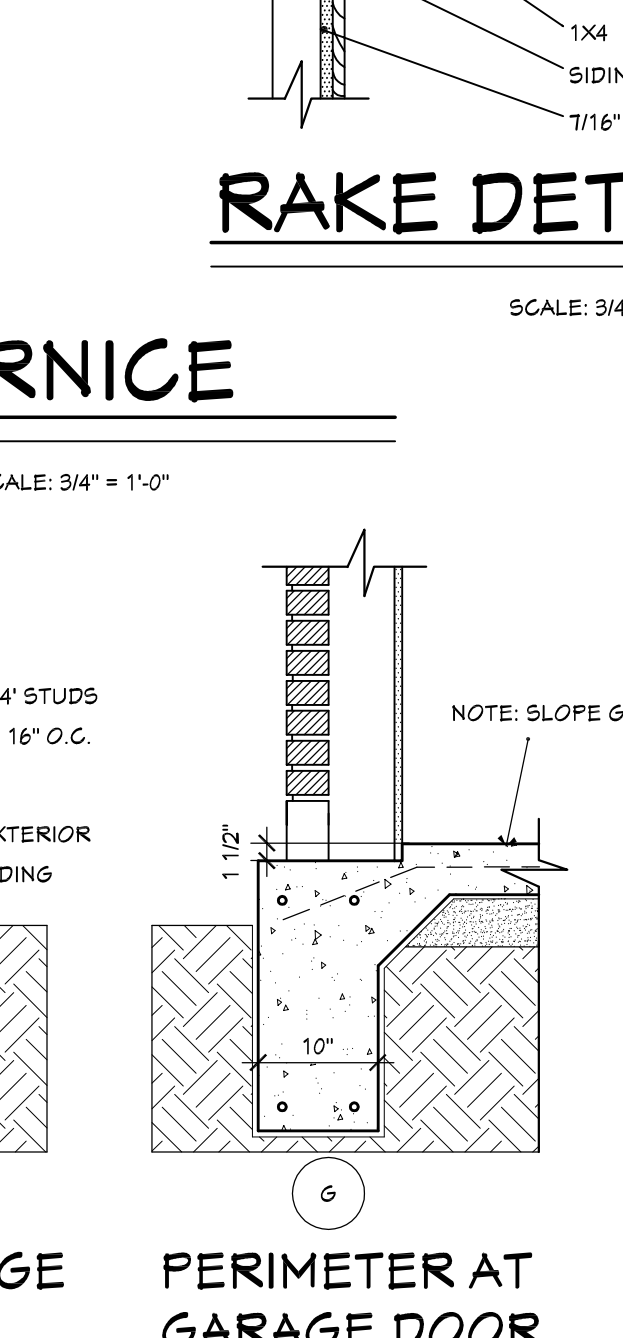
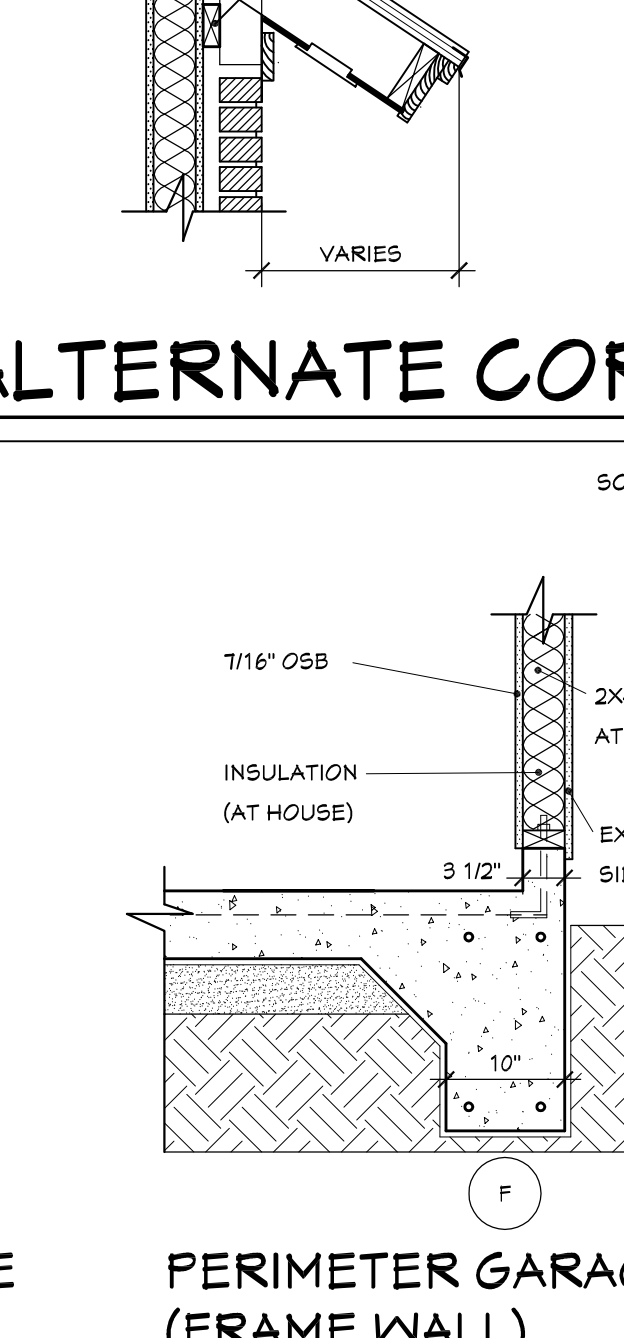
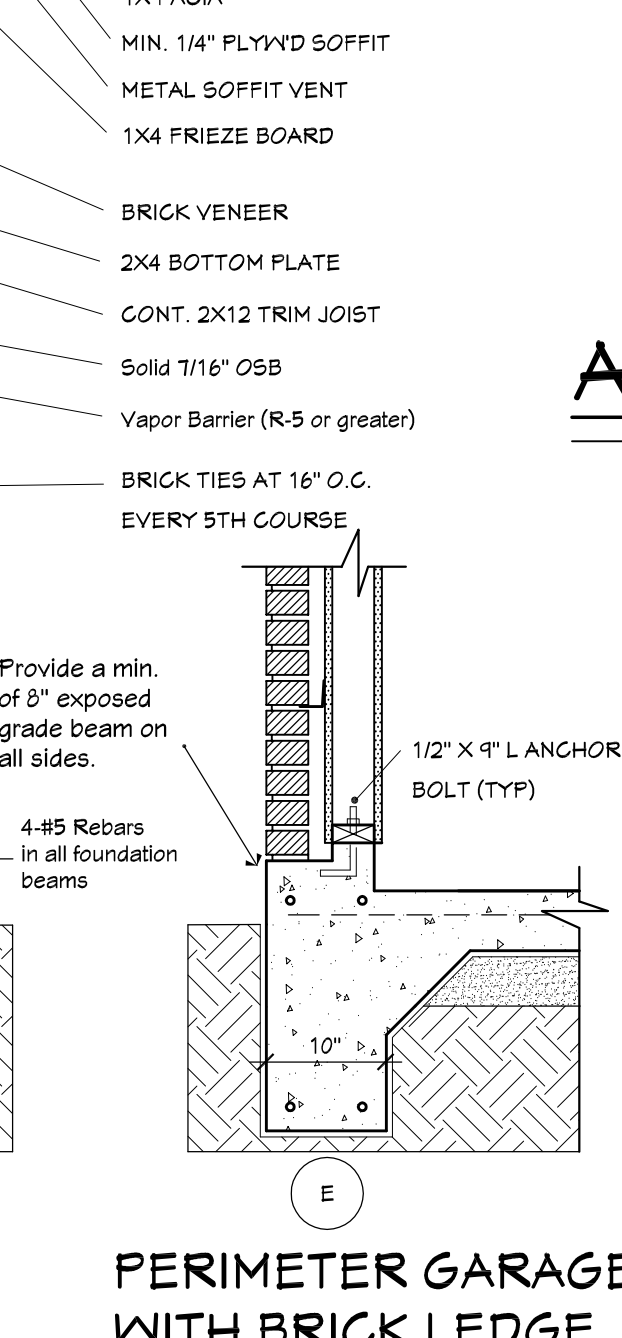
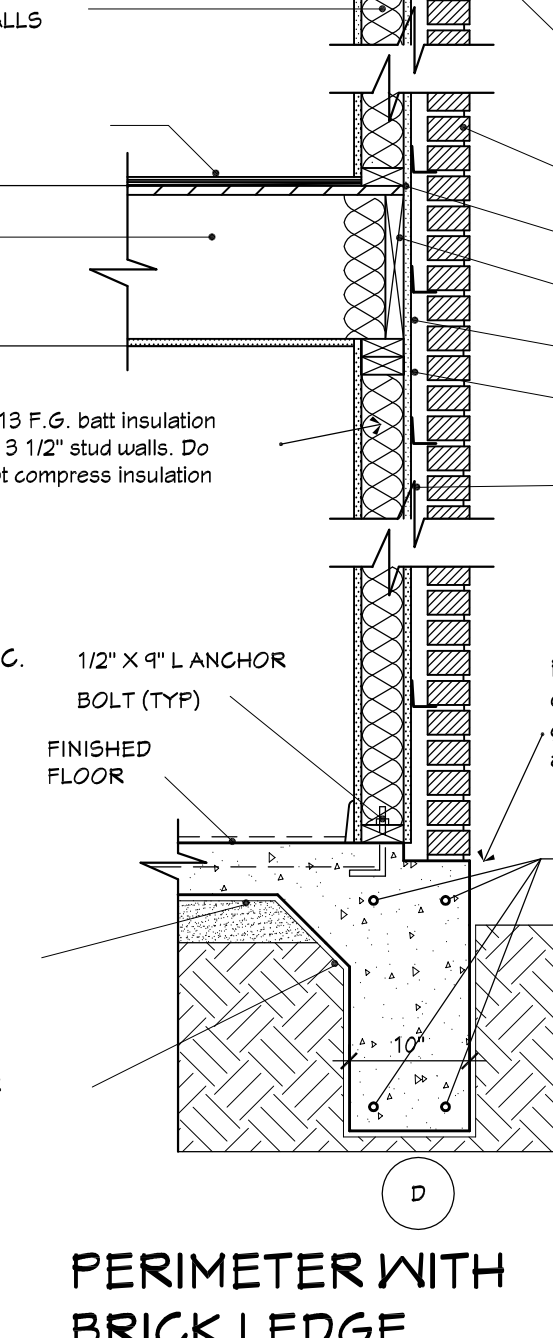
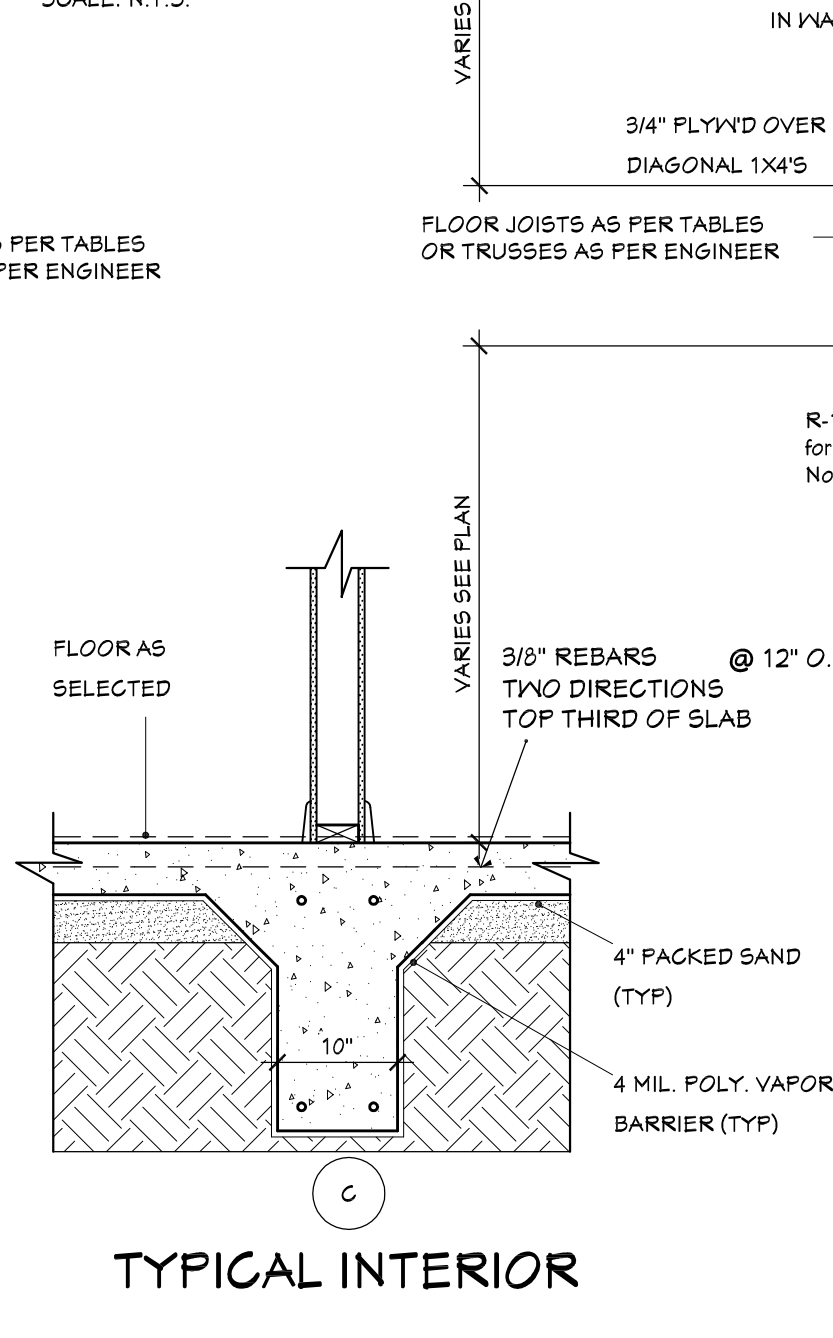
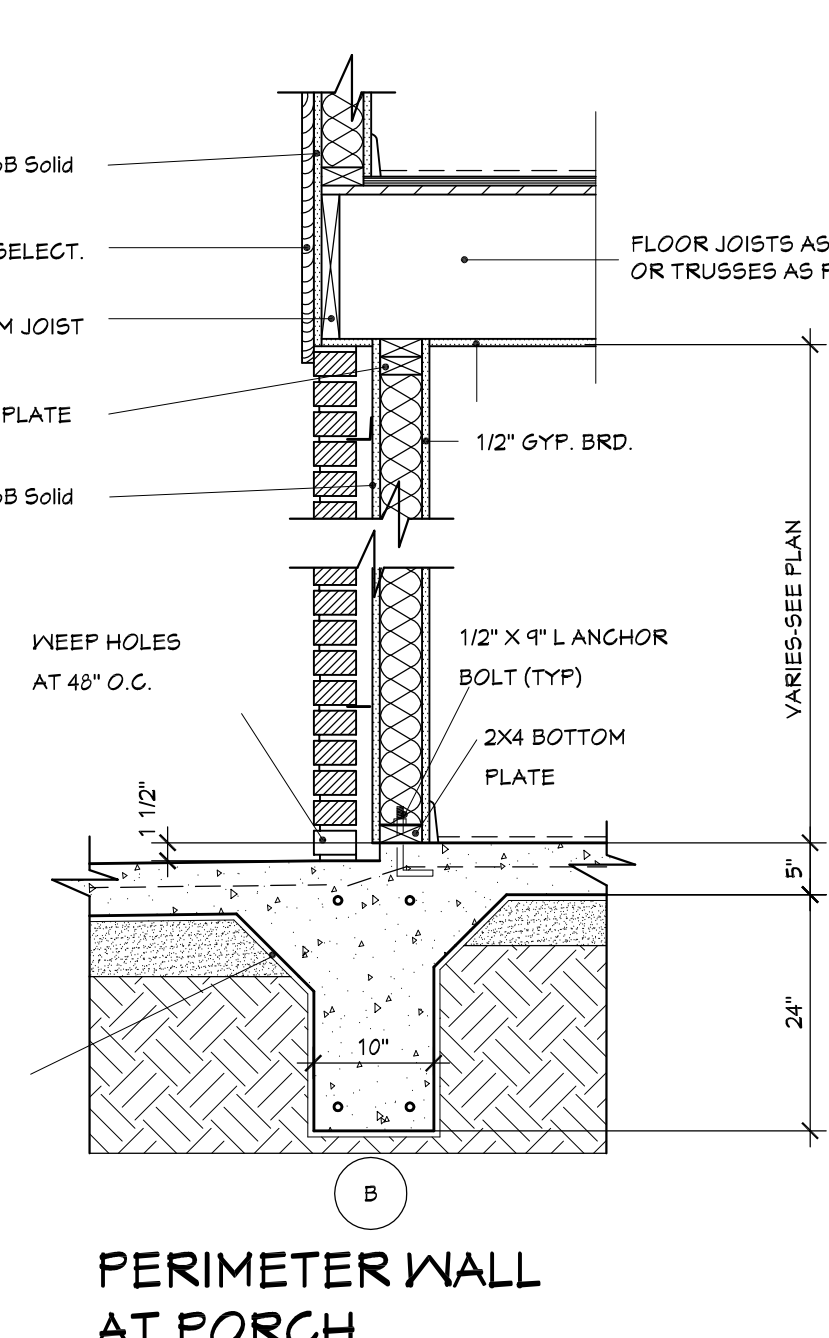
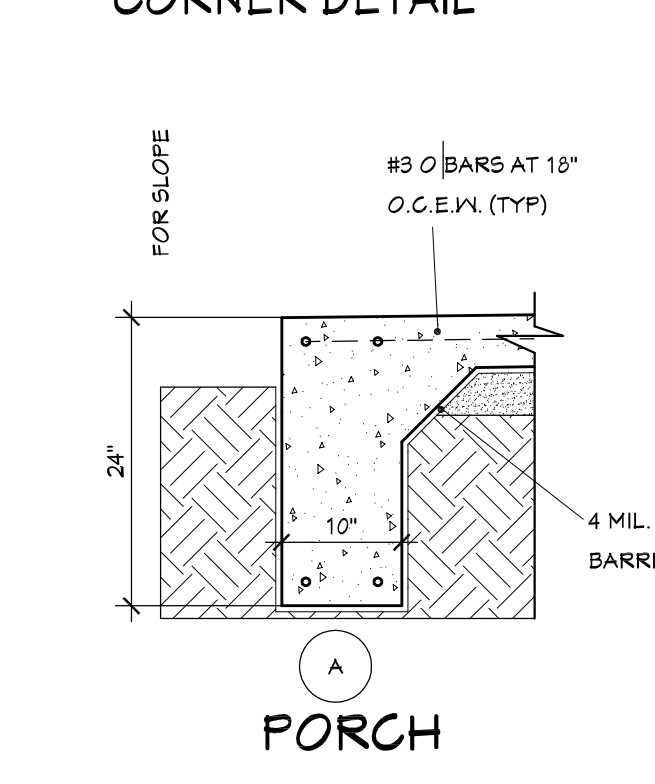
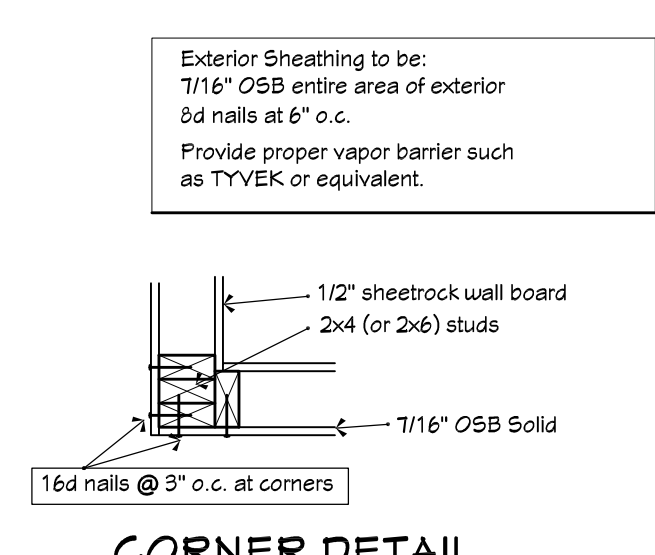

FOUNDATION DETAILS

SCALE: 3/4" = 1'-0"
REFER TO ENGINEER'S PLANS AND DETAILS WHEN A POST TENSIONED, BASEMENT OR CRAWL SPACE FOUNDATION IS SPECIFIED.

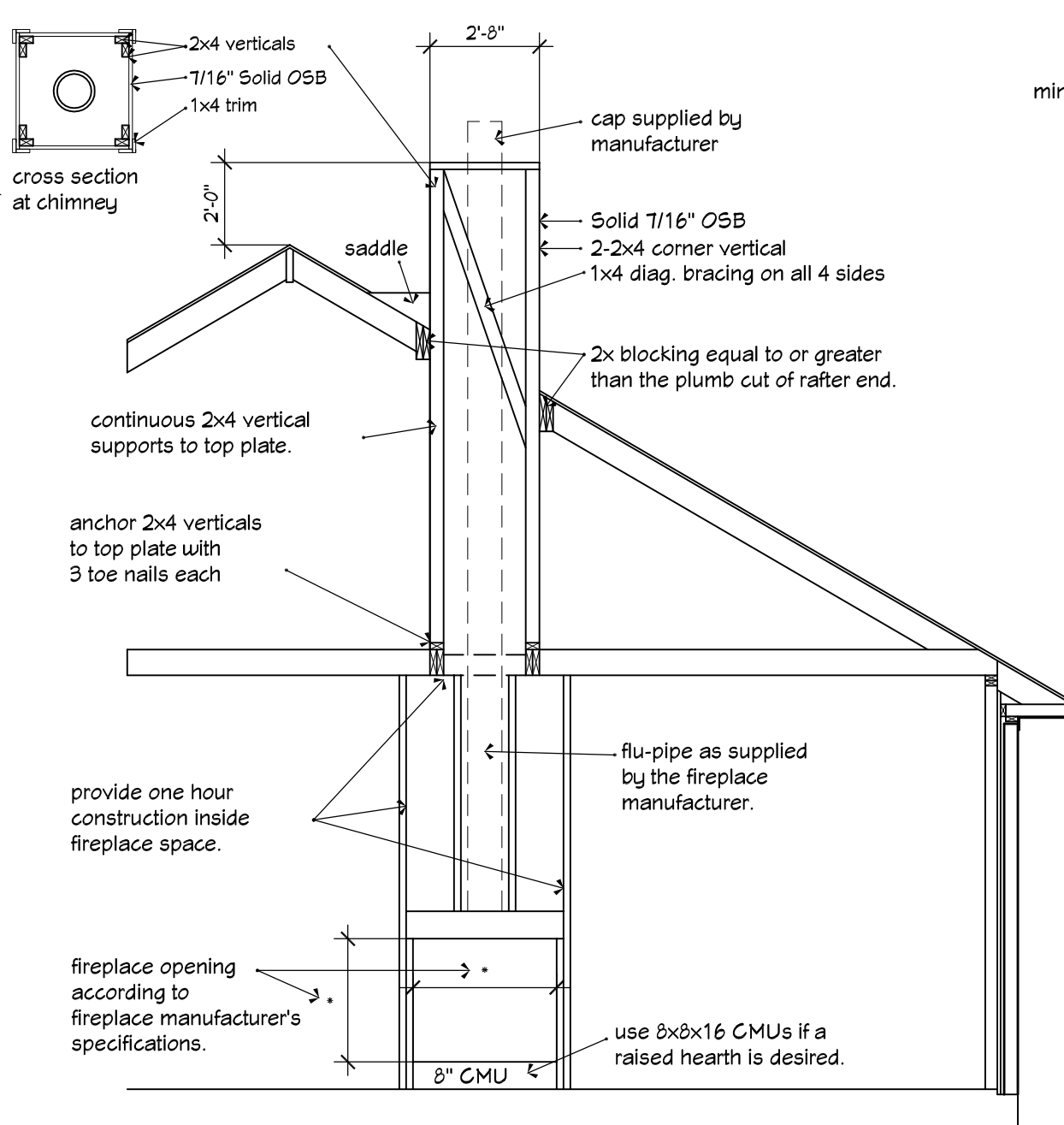

WOOD CHIMNEY DETAIL

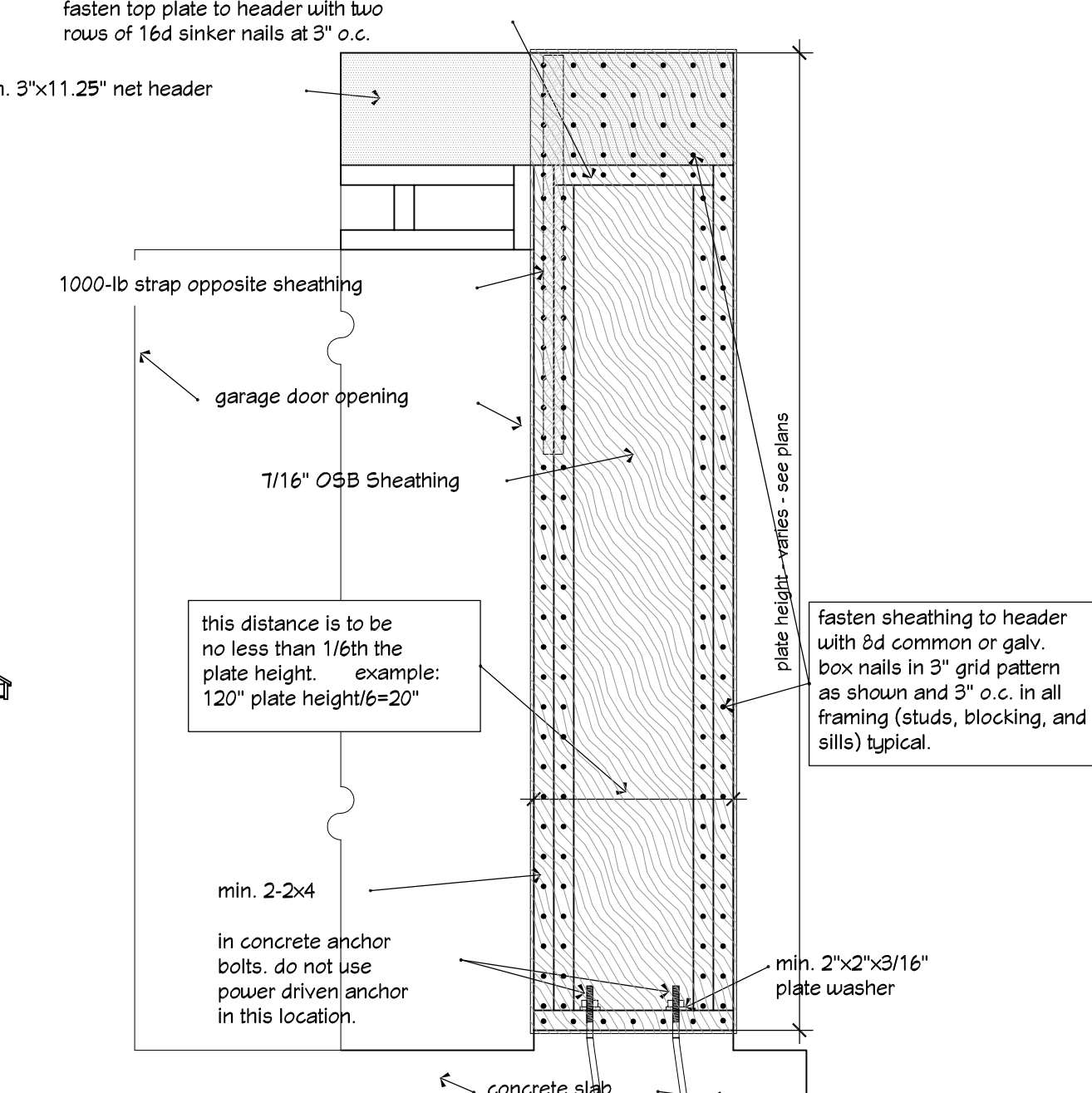

GARAGE CORNER DETAIL

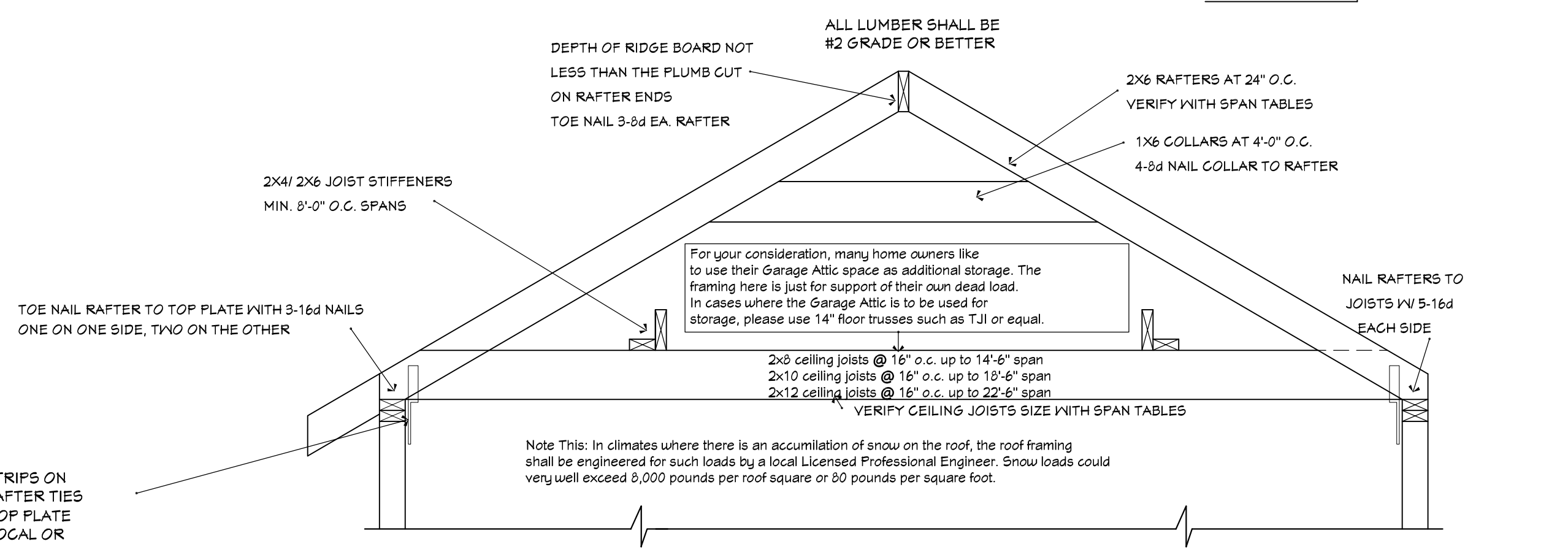

GARAGE ROOF BRACING

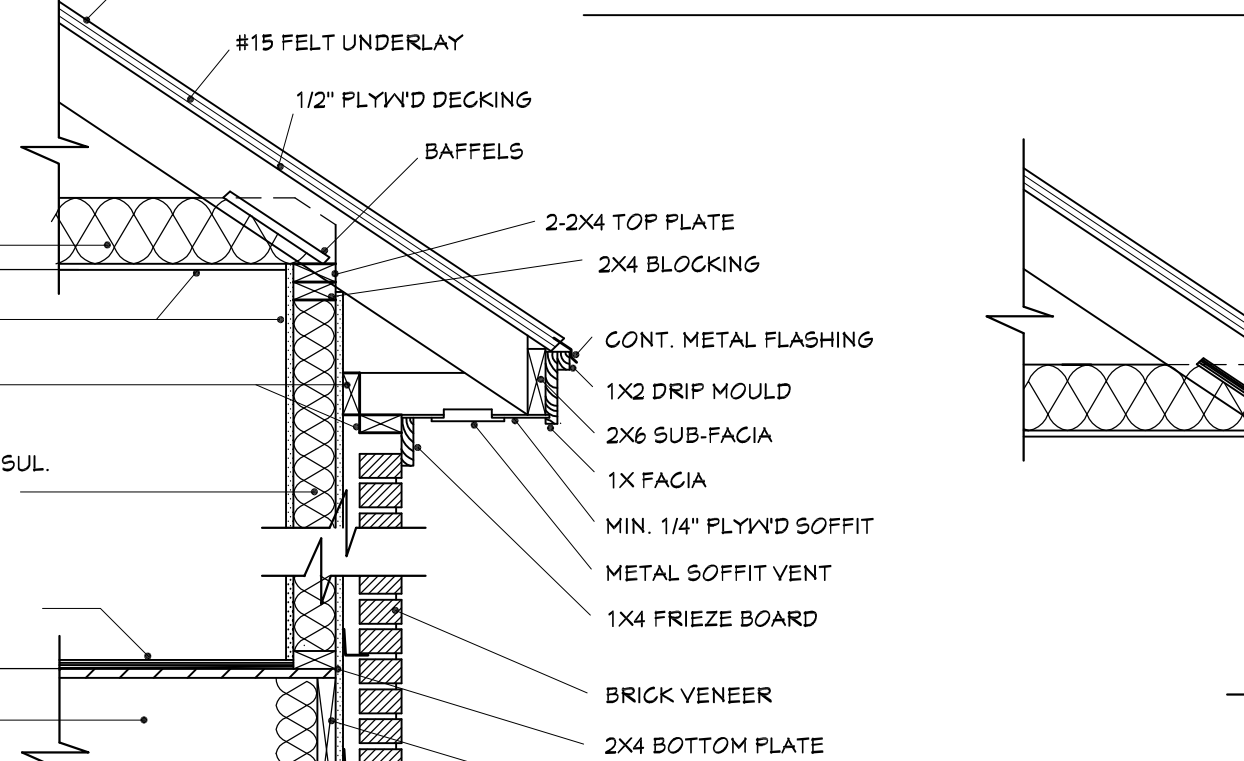

ALTERNATE CORNICE

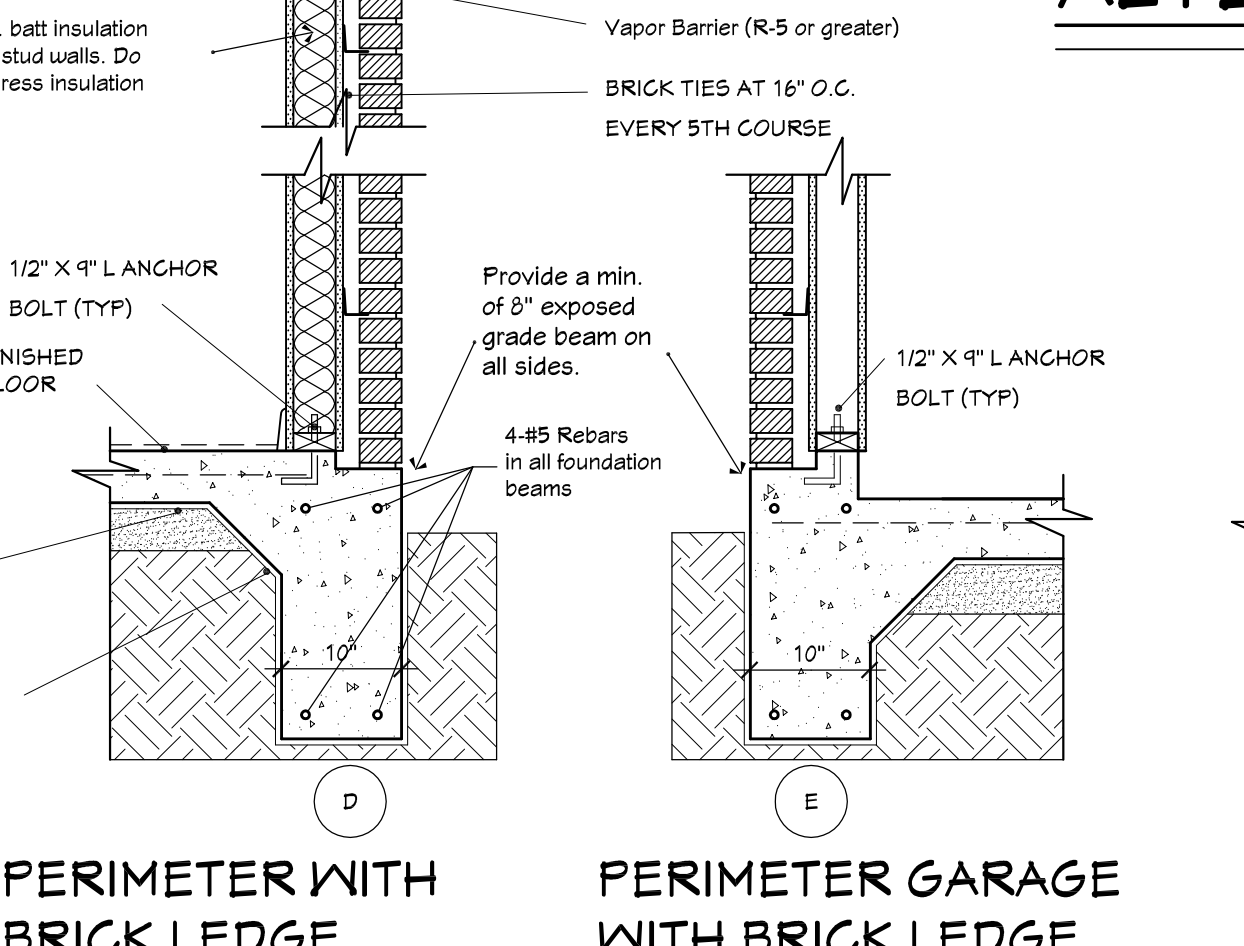

GENERAL FOUNDATION NOTES:

- These foundation notes and details are not applicable when a post tensioned slab is specified. Please refer to the Engineer's notes and details.
- These notes and details were taken from the Dallas, Texas area office of the U.S. Department of Housing and Urban Development, Type "C" Foundation.
- Provide a min. of 4" sand fill except in areas with a high water table. Where a high water table occurs use gravel, crushed stone or comparable material.
- All beams shall penetrate a minimum of 6" into undisturbed soils.
- No "dead end" beams shall be allowed.
- All beams and slab reinforcement to extend within 1-1/2" of exterior forms.
- All concrete shall have a 28 day ultimate compressive strength of 3,000 p.s.i.
- Reinforcing shall be tied and supported every 48" or less.
- Lap all bar reinforcing 40 diameters. That's 15" with 3/8" rebars.
- This foundation detail sheet is provided for your convenience. Use at your own risk. It is advised that a qualified licensed Professional Engineer review this foundation design and the soil report to assure this foundation design is correct for the site it is to be built on.

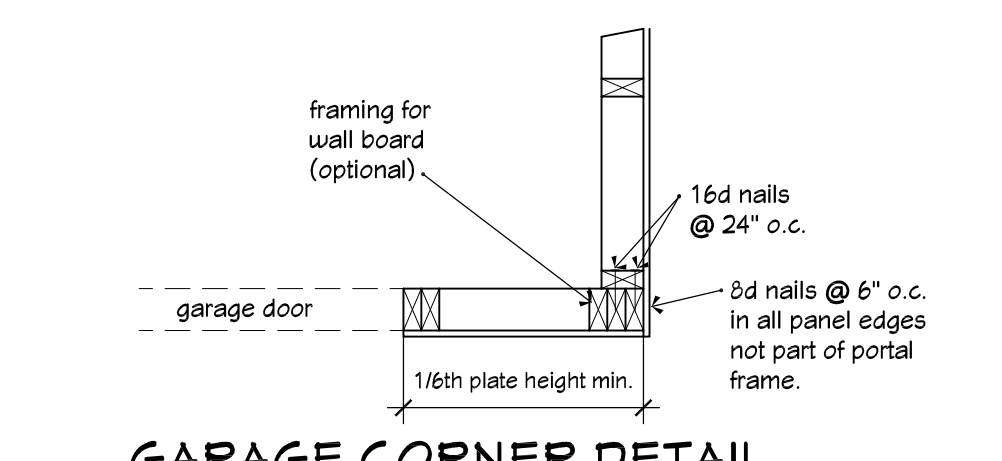

GARAGE CORNER DETAIL

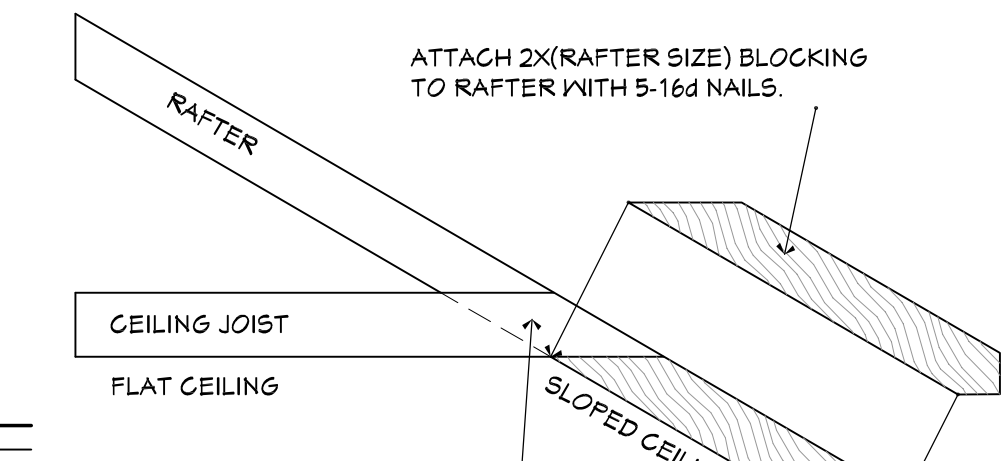
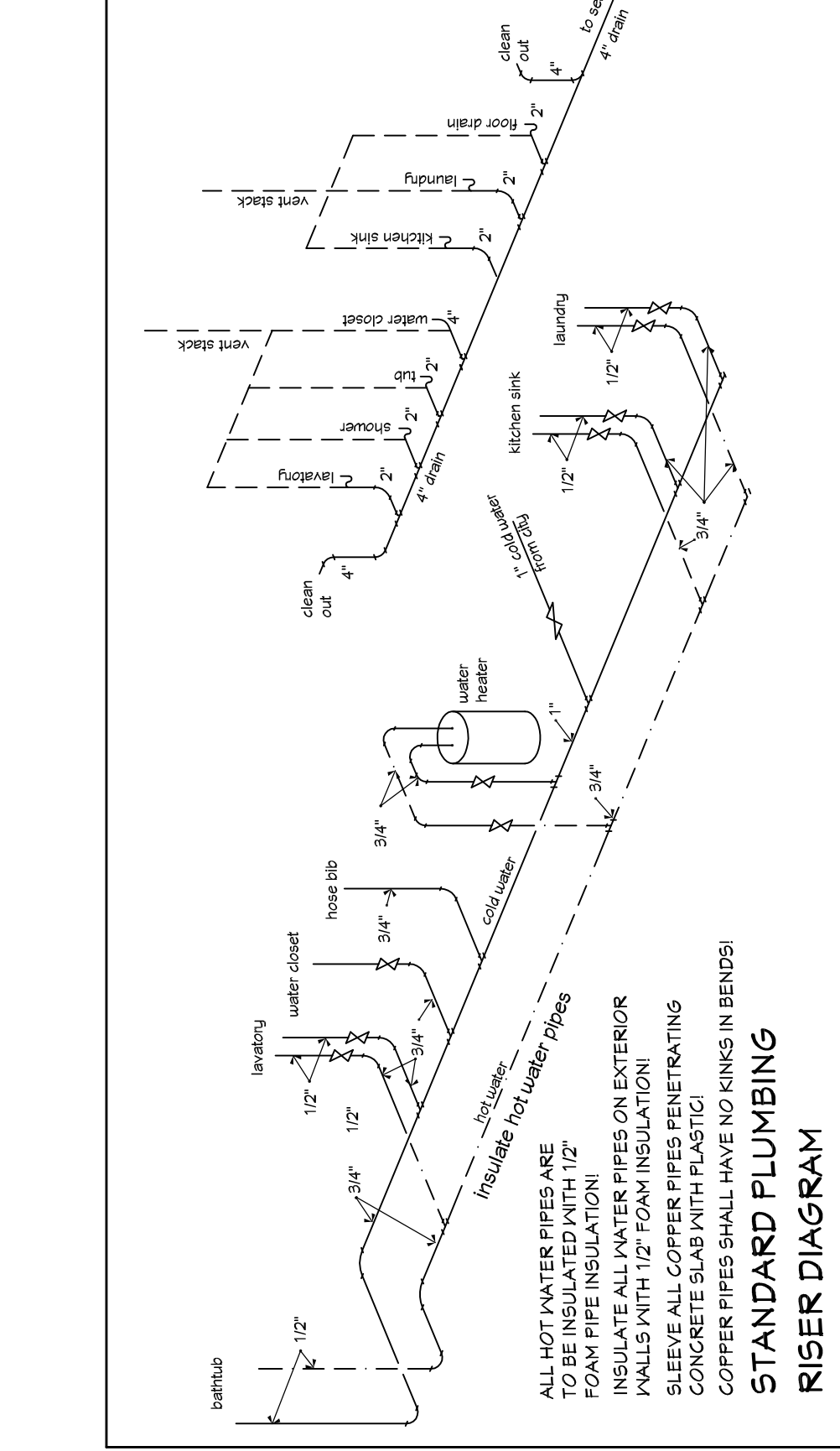

SLOPE CEILING DETAIL

REVISIONS:

J. Karlovich Home Design

(214) 674-0290 : Phone
jkarlovichhomedesign.com

These plans are intended to provide the basic construction information necessary to substantially complete this structure. Like most home designs, this firm, J. Karlovich Home Design, is not being an architectural or engineering firm stands no liability for structural or architectural design integrity. Every effort has been made to ensure all dimensions are correct and governmental regulations have been met. If any error or omission does occur it is the sole responsibility of the contractor and/or the owner to correct the error and/or omission at his own expense and not the responsibility of J. Karlovich Home Design. These plans are intended to be a one time use for this address ONLY.

STANDARD CONSTRUCTION DETAILS

Refer to Engineer Plans for Specific Details

(c) copyright 2020 J. Karlovich Home Design

SHEET NO. DETAILS